

PROGRAMMING NOTE

Queued Output Match TPU Function (QOM)

By Jeff Wright

1 Functional Overview

The QOM function generates complex pulse trains without CPU intervention using a sequence of output matches. An output match causes a programmable pin response when a user-defined value is matched by the value of a free-running counter. QOM generates multiple output matches using a queue of offset times and pin responses in parameter RAM. Queue size can vary from application to application. Various modes of queued operation are supported.

2 Detailed Description

Entries in the QOM queue are incremental match offsets, not absolute match times. The next match time in a sequence is calculated by adding the next queued offset to the time of the last match. If the match is the first match in a sequence, the first offset value in the queue is added to a selectable reference time.

The reference time from which the first match in a sequence is scheduled can be the immediate value of the selected TCR, the time of the last match of a previous sequence, or a time contained in parameter RAM. Using the time of the last match of a previous sequence as a reference allows a series of sequences to be chained together. Using a time value from parameter RAM allows a chain of output matches to be referenced to a time derived by another TPU channel.

Pin response (high or low transition) when a match occurs is fully programmable. Pin response is determined by the value of bit 0 in each queue entry.

The function can operate in single-shot mode, in which a sequence of match outputs is generated once; in loop mode, in which a sequence of match outputs is generated a specified number of times (1 to 256), or in continuous mode; in which the entire sequence repeats until the channel is disabled or the TPU receives a new host service request. Linked operation allows the function to be triggered by a link from another TPU channel. All loop modes can be used in conjunction with linked operation.

In single-shot mode and in loop mode, the event time of the last match in the queue is written back into parameter RAM for the CPU to access. Three host service states allow the function to be initiated with the output pin high, low, or with no change in state.

If adjacent queue offset values are programmed for the same pin response, duration of an output event can effectively be extended beyond the normal 8000 TCR-count limit imposed by the TPU greater-than-or-equal-to comparator.

A detailed description of the QOM algorithm, including a state diagram, is provided for reference at the end of this document.

3 Function Code Size

Total TPU function code size determines what combination of functions can fit into a given ROM or emulation memory microcode space. QOM function code size is:

41 μ instructions + 8 entries = **49 long words**

4 Function Parameters

This section provides detailed descriptions of function parameters stored in channel parameter RAM. **Figure 1** shows TPU parameter RAM address mapping. **Figure 2** shows the parameter RAM assignment used by the function. In the diagrams, Y = M111, where M is the value of the module mapping bit (MM) in the system integration module configuration register (Y = \$7 or \$F).

Channel Number	Base Address	Parameter Address							
		0	1	2	3	4	5	6	7
0	\$YFFF##	00	02	04	06	08	0A	—	—
1	\$YFFF##	10	12	14	16	18	1A	—	—
2	\$YFFF##	20	22	24	26	28	2A	—	—
3	\$YFFF##	30	32	34	36	38	3A	—	—
4	\$YFFF##	40	42	44	46	48	4A	—	—
5	\$YFFF##	50	52	54	56	58	5A	—	—
6	\$YFFF##	60	62	64	66	68	6A	—	—
7	\$YFFF##	70	72	74	76	78	7A	—	—
8	\$YFFF##	80	82	84	86	88	8A	—	—
9	\$YFFF##	90	92	94	96	98	9A	—	—
10	\$YFFF##	A0	A2	A4	A6	A8	AA	—	—
11	\$YFFF##	B0	B2	B4	B6	B8	BA	—	—
12	\$YFFF##	C0	C2	C4	C6	C8	CA	—	—
13	\$YFFF##	D0	D2	D4	D6	D8	DA	—	—
14	\$YFFF##	E0	E2	E4	E6	E8	EA	EC	EE
15	\$YFFF##	F0	F2	F4	F6	F8	FA	FC	FE

— = Not Implemented (reads as \$00)

Figure 1 TPU Channel Parameter RAM CPU Address Map

	15	14	13	12	11	10	9	8	7	6	5	4	3	2	1	0
\$YFFFW0	REF_ADDR							B	LAST_OFF_ADDR							A
\$YFFFW2	LOOP_CNT				(LAST_MATCH_TIM)				OFF_PTR				C			
\$YFFFW4	OFFSET_1															∞
\$YFFFW6	OFFSET_2															∞
\$YFFFW8	OFFSET_3															∞
\$YFFFWA	OFFSET_4															∞
\$YFFFWC	OFFSET_5*															∞
\$YFFFWE	OFFSET_6*															∞
\$YFFF (W + 1) 0	OFFSET_7*															∞
\$YFFF (W + 1) 2	OFFSET_8*															∞
↓	↓															↓
\$YFFF (W + 1) 14	OFFSET_14*															∞

* Not available on all channels

W = Channel number

Parameter Write Access

	Written by CPU
	Written by TPU
	Written by CPU and TPU
	Unused parameters

Bit Encoding

A	Timebase Selection
0	Use TCR1 as Timebase
1	Use TCR2 as Timebase

∞	Edge Selection
0	Falling Edge at Match
1	Rising Edge at Match

B:C	Reference for First Match
00	Immediate TCR Value
01	Last Event Time
10	Value Pointed to by REF_ADDR
11	Last Event Time

Figure 2 QOM Function Parameter RAM Assignment

4.1 BIT_A

This control bit determines which of the two TPU timer counters is used as a timebase for an output match sequence. The timer counter is selected during the host service request states and the link state (states 1, 2, 3, 4). When BIT_A is equal to zero, TCR1 is selected as the timebase. When BIT_A is equal to one, TCR2 is selected.

4.2 LAST_OFF_ADDR

This parameter contains the upper seven bits of the PRAM address of the last entry in the match offset queue (for example, a value of %0001101 indicates parameter 5 of channel 1 is the last queue entry). It is used during the match state (state 5) to determine when the end of the queue has been reached.

4.3 BIT_B

This control bit and BIT_C are used during the host service and link states (states 1, 2, 3, 4) to determine the reference time for the first match after initialization. Reference time can be:

An immediate TCR value

A value in parameter RAM pointed to by REF_ADDR

The event time of the last match in the previous sequence of matches.

4.4 REF_ADDR

When the values of BIT_B and BIT_C select a value in parameter RAM as a reference time for the first match after initialization, this parameter contains the upper seven bits of the PRAM address of the value to be used. When an immediate TCR reference or last event reference is selected, it is unnecessary to provide a REF_ADDR value.

4.5 OFF_PTR

This 7-bit parameter is normally used as a queue pointer. It is updated by the TPU after each match occurs. OFF_PTR value also determines whether linked operation is selected. If OFF_PTR contains a non-zero value during a host service state, linked operation is selected. In single-shot mode or loop mode, OFF_PTR is overwritten by LAST_MATCH_TIM at the end of the match sequence.

4.6 BIT_C

This control bit and BIT_B are used during the host service and link states (states 1, 2, 3, 4) to determine the reference time for the first match after initialization. Reference time can be:

An immediate TCR value

A value in parameter RAM pointed to by REF_ADDR

The event time of the last match in the previous sequence of matches.

4.7 LOOP_CNT

This parameter is used as a counter during loop mode operation. The value in LOOP_CNT determines how many times the queued match sequence is repeated. LOOP_CNT is initialized by the CPU and decremented toward zero by the TPU. When LOOP_CNT reaches \$00 after decrementing, the function stops and LOOP_CNT is overwritten by LAST_MATCH_TIM. If LOOP_CNT is initialized to \$00, the function loops 256 times.

4.8 LAST_MATCH_TIM

This parameter stores the time of the last match event in a sequence. The TPU stores the value after completion of a match sequence during single-shot mode or loop mode operation. OFF_PTR, LOOP_CNT and BIT_C are overwritten by the LAST_MATCH_TIM value. LAST_MATCH_TIM is written after the last match has occurred but before the TPU requests interrupt service from the CPU.

4.9 OFFSET_N

These parameters form the match offset queue. The 15 upper bits of each parameter contain a shifted offset. The offset value is shifted right once before being used. This means that the maximum offset from a previous match time or reference time is \$7FFF TCR counts. Bit 0 of the offset parameter determines whether a pin goes high or low as a result of a match event. When bit 0 is equal to zero, the pin goes low; when it is equal to one, the pin goes high. To program a pin to go high \$1000 TCR counts after the previous match, for example, the CPU must store a value of \$2001 in the appropriate OFFSET_N parameter.

There can be from one to fourteen queue entries, depending upon which TPU channels are assigned to the QOM function. When channels 0 to 13 are used, the maximum number of entries is four; when channels 14 and 15 are used, the maximum number of entries is normally six. Table length is determined by the value of LAST_OFF_ADDR, which points to the last queue entry. There is one special case — when channel 15 is not being used, the channel 14 LAST_OFF_ADDR pointer can be set to point into channel 15 PRAM, providing up to 14 table queue entries.

Offsets in the queue are used in sequence, starting with OFFSET_1. OFFSET_1 must always be the third parameter in QOM channel parameter RAM.

5 Host Interface to Function

This section provides information concerning the TPU host interface to the QOM function. Figure 3 is a TPU address map. Detailed TPU register diagrams follow the figure. In the diagrams, Y = M111, where M is the value of the module mapping bit (MM) in the system integration module configuration register (Y = \$7 or \$F).

Address	15	8	7	0
\$YFFE00	TPU MODULE CONFIGURATION REGISTER (TPUMCR)			
\$YFFE02	TEST CONFIGURATION REGISTER (TCR)			
\$YFFE04	DEVELOPMENT SUPPORT CONTROL REGISTER (DSCR)			
\$YFFE06	DEVELOPMENT SUPPORT STATUS REGISTER (DSSR)			
\$YFFE08	TPU INTERRUPT CONFIGURATION REGISTER (TICR)			
\$YFFE0A	CHANNEL INTERRUPT ENABLE REGISTER (CIER)			
\$YFFE0C	CHANNEL FUNCTION SELECTION REGISTER 0 (CFSR0)			
\$YFFE0E	CHANNEL FUNCTION SELECTION REGISTER 1 (CFSR1)			
\$YFFE10	CHANNEL FUNCTION SELECTION REGISTER 2 (CFSR2)			
\$YFFE12	CHANNEL FUNCTION SELECTION REGISTER 3 (CFSR3)			
\$YFFE14	HOST SEQUENCE REGISTER 0 (HSQR0)			
\$YFFE16	HOST SEQUENCE REGISTER 1 (HSQR1)			
\$YFFE18	HOST SERVICE REQUEST REGISTER 0 (HSRR0)			
\$YFFE1A	HOST SERVICE REQUEST REGISTER 1 (HSRR1)			
\$YFFE1C	CHANNEL PRIORITY REGISTER 0 (CPR0)			
\$YFFE1E	CHANNEL PRIORITY REGISTER 1 (CPR1)			
\$YFFE20	CHANNEL INTERRUPT STATUS REGISTER (CISR)			
\$YFFE22	LINK REGISTER (LR)			
\$YFFE24	SERVICE GRANT LATCH REGISTER (SGLR)			
\$YFFE26	DECODED CHANNEL NUMBER REGISTER (DCNR)			

Figure 3 TPU Address Map

CIER — Channel Interrupt Enable Register

\$YFFE0A

15	14	13	12	11	10	9	8	7	6	5	4	3	2	1	0
CH 15	CH 14	CH 13	CH 12	CH 11	CH 10	CH 9	CH 8	CH 7	CH 6	CH 5	CH 4	CH 3	CH 2	CH 1	CH 0

CH	Interrupt Enable
0	Channel interrupts disabled
1	Channel interrupts enabled

CFSR[0:3] — Channel Function Select Registers

\$YFFE0C – \$YFFE12

15	14	13	12	11	10	9	8	7	6	5	4	3	2	1	0
CFS (CH 15, 11, 7, 3)				CFS (CH 14, 10, 6, 2)				CFS (CH 13, 9, 5, 1)				CFS (CH 12, 8, 4, 0)			

CFS[4:0]	Function Number
XXXX	QOM Function Number (Assigned during microcode assembly)

HSQR[0:1] — Host Sequence Registers

\$YFFE14 – \$YFFE16

15	14	13	12	11	10	9	8	7	6	5	4	3	2	1	0
CH 15, 7		CH 14, 6		CH 13, 5		CH 12, 4		CH 11, 3		CH 10, 2		CH 9, 1		CH 8, 0	

CH	Operating Mode
00	Single-Shot Mode
01	Loop Mode
10	Continuous Mode
11	Continuous Mode

HSRR[1:0] — Host Service Request Registers

\$YFFE18 – \$YFFE1A

15	14	13	12	11	10	9	8	7	6	5	4	3	2	1	0
CH 15, 7		CH 14, 6		CH 13, 5		CH 12, 4		CH 11, 3		CH 10, 2		CH 9, 1		CH 8, 0	

CH	Initialization
00	No Host Service (Reset Condition)
01	Initialize, No Pin Change
10	Initialize, Pin Low
11	Initialize, Pin High

CPR[1:0] — Channel Priority Registers

\$YFFE1C – \$YFFE1E

15	14	13	12	11	10	9	8	7	6	5	4	3	2	1	0
CH 15, 7		CH 14, 6		CH 13, 5		CH 12, 4		CH 11, 3		CH 10, 2		CH 9, 1		CH 8, 0	

CH	Channel Priority
00	Disabled
01	Low
10	Middle
11	High

CISR — Channel Interrupt Status Register

\$YFFE20

15	14	13	12	11	10	9	8	7	6	5	4	3	2	1	0
CH 15	CH 14	CH 13	CH 12	CH 11	CH 10	CH 9	CH 8	CH 7	CH 6	CH 5	CH 4	CH 3	CH 2	CH 1	CH 0

CH	Interrupt Status
0	Channel interrupt not asserted
1	Channel interrupt asserted

6 Function Configuration

The CPU configures the QOM function as follows.

1. The appropriate channel priority bits are cleared, disabling the channel.
2. The QOM function number is written to the channel function select bits.
3. BIT_A, BIT_B, BIT_C, LAST_OFF_ADDR, REF_ADDR (if required), OFF_PTR, LOOP_CNT and queue values OFFSET_1 through OFFSET_N are written to channel parameter RAM.
4. The host sequence bits are written, selecting the desired mode of operation.
5. An HSR is issued to initialize the function and set the channel pin to the desired initial output state.
6. The channel priority bits are written to enable the function and assign channel priority.
7. The TPU executes the selected initialization state.

After initialization, the TPU makes an interrupt service request. If the appropriate TPU interrupt enable bit is set, the CPU recognizes and services the request. In single shot and loop modes, another interrupt service request is made after completion of the match sequence.

To reinitialize the QOM function after completion of a sequence of matches, the CPU must first refill the match table with new values, then reinitialize LOOP_CNT, OFF_PTR and BIT_C. LAST_OFF_ADDR must be changed if the new queue is a different size from the last. Finally the CPU must issue the appropriate HSR.

7 Performance and Use of Function

7.1 Performance

Like all TPU functions, QOM function performance in an application is to some extent dependent upon the service time (latency) of other active TPU channels. This is due to the operational nature of the scheduler. When a single QOM channel is in use and no other TPU channels are active, the minimum time between successive matches is 36 CPU clock cycles in single shot and continuous modes and 44 CPU clocks in loop mode. When more TPU channels are active, performance decreases. However, worst-case latency in any TPU application can be closely estimated. To analyze the performance of an application that appears to approach the limits of the TPU, use the guidelines given in the TPU reference manual and the information in the QOM state timing table below.

Table 1 Queued Output Match Function — State Timing

State Number & Name	Max CPU Clock Cycles	RAM Accesses by TPU
S1 QOM_HI Linked operation Normal modes	12 48	2 7
S2 QOM_LO Linked operation Normal modes	14 50	2 7
S3 QOM_NC Linked operation Normal modes	14 50	2 7
S4 QOM_LNK	36	6
S5 QOM_M Single Shot Loop Continuous	22 30 22	4 4 4

NOTE: Execution times do not include the time slot transition time (TST = 10 or 14 CPU clocks)

7.2 Using Qom for Pulse-Width Modulation

The QOM function can be used to generate a pulse-width modulated output in systems that do not have a dedicated TPU PWM function. A PWM output is generated using continuous mode and two match offsets. One offset is configured to generate a rising edge, and the other is configured to generate a falling edge. The offset that generates the rising edge is the low-time parameter and the offset that generates the falling edge is the high-time parameter. Modulation is achieved by varying the offset values in the queue. Example D shows PWM setup and output. 100% and 0% duty cycles are easily obtained by configuring both offsets to generate either a rising edge (100% duty cycle) or a falling edge (0%).

7.3 Initialization to First Match Delay

When an immediate TCR value is used as a reference for the first queued match time, there is a delay between the time that the channel pin is initialized and the time that the TCR is read. This delay is caused by TPU code execution during states 1 and 2. The delay causes the period between pin initialization and the output caused by the first match event to be longer than the period specified by the offset value in the first queue entry. The additional time is equivalent to 16 CPU clocks when TCR1 is the time base and 18 CPU clocks when TCR2 is the time base. If the duration of the initial pin state is critical, it may be necessary to take this additional time into account when the first offset value is specified.

7.4 Linked Operation

During linked operation, if an additional link is received after the function has started scheduling matches, state 5 (QOM_LNK) is re-executed. Executing state 5 again causes OFF_PTR to be reset to the start of the queue, and thus restarts the match sequence. When this happens, any pending match is replaced by a new scheduled match that is OFFSET_1 counts from the last match event. If an additional link is received while a loop is executing, the sequence repeats, but LOOP_CNT is not reset to the initial value. When a complete match sequence has been executed and the function has stopped, additional link requests are ignored.

7.5 Changing Mode

The host sequence bits are used to select QOM function operating mode. Change host sequence bit values only when the function is stopped or disabled (channel priority bits =%00). Disabling the channel before changing mode avoids conditions that cause indeterminate operation, such as selecting loop mode without initializing the LOOP_CNT parameter.

7.6 Using the REF_ADDR Parameter

Although the examples in this note that use a reference time pointed to by REF_ADDR have reference times that occur before the HSR or link that initiates the function, this need not be the case. A first match is scheduled correctly when the HSR or link occurs before the reference time, as shown in **Figure 4**.

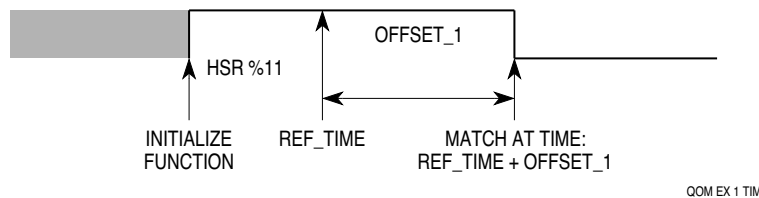

Figure 4 Scheduling of First Match When HSR Occurs Before Reference Time

When $(REF_TIME + OFFSET_1)$ is outside the range {Current TCR to Current TCR + \$8000}, an immediate match occurs. This is due to the nature of the TPU greater-than-or-equal-to comparator. In **Figure 5**, two matches are referenced to REF_TIME. The first match occurs immediately, but the second is correctly referenced to the time $(REF_TIME + OFFSET_1)$.

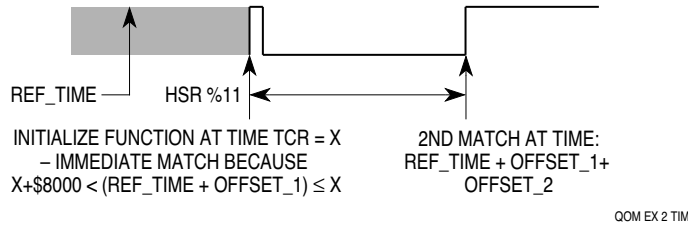

Figure 5 Scheduling An Immediate Match

7.7 Long Match Times

The QOM function can produce long apparent match times by using two or more queue entries programmed for the same pin response. This technique can extend a pin state change well beyond the normal limit of \$8000 TCR counts. Because very short match times can have an adverse effect on overall TPU performance, it is best to split a long match time into even segments rather than following a very long segment with a very short segment. For example, if a total match time of \$8100 counts is required, use two \$4080-count match times rather than one match time of \$7FFF counts and another of \$101 counts.

8 Queued Output Match Examples

The QOM function is capable of generating complex output waveforms. The following examples give an indication of the capabilities of the function. Each example includes a description of the example, a diagram of the initial parameter RAM content, initial control bit settings, and a diagram of the output waveform. Unless otherwise noted, all examples use TPU channel 4. The examples are simplified to illustrate certain features of the function — long match times are not split into even segments, and the interrupt service request that is always generated after host and link states is not shown.

8.1 Example A

8.1.1 Description

Single-shot mode. Generates a single falling edge with no forced start condition and with a delay of \$500 TCR2 counts from an immediate reference.

8.1.2 Initialization

Load parameter RAM as shown. Write HSQ =%00, then issue HSR =%01 to initialize and start function.

Table 2 QOM Channel Parameter RAM

	15	8								0								
\$YFFF40	X	X	X	X	X	X	X	0	0	1	0	0	0	1	0	1		
\$YFFF42	X	X	X	X	X	X	X	X	0	0	0	0	0	0	0	0		
\$YFFF44	0	0	0	0	1	0	1	0	0	0	0	0	0	0	0	0	OFFSET_1	
\$YFFF46	X	X	X	X	X	X	X	X	X	X	X	X	X	X	X	X		
\$YFFF48	X	X	X	X	X	X	X	X	X	X	X	X	X	X	X	X		
\$YFFF4A	X	X	X	X	X	X	X	X	X	X	X	X	X	X	X	X		

OFFSET_1 = \$500

8.1.3 Output Waveform

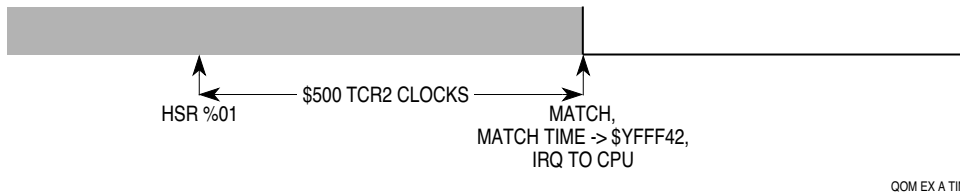

8.2 Example B

Loop mode. Generates two active-high pulses with a duration of \$E000 TCR1 clocks, separated by a \$400 TCR1 clock delay. Starts \$400 clocks after an immediate reference. Uses two consecutive queue entries programmed for the same pin response to produce a match time greater than \$8000 TCR1 clocks.

8.2.1 Initialization

Load parameter RAM as shown. Write HSQ = %01, then issue HSR = %10 to initialize and start function.

Table 3 QOM Channel Parameter RAM

	15	8	0													
\$YFFF40	X	X	X	X	X	X	0	0	1	0	0	1	0	0	0	
\$YFFF42	0	0	0	0	0	1	0	0	0	0	0	0	0	0	0	
\$YFFF44	0	0	0	0	1	0	0	0	0	0	0	0	0	0	0	OFFSET_1
\$YFFF46	1	1	1	1	1	1	1	1	1	1	1	1	1	1	1	OFFSET_2
\$YFFF48	1	1	0	0	0	0	0	0	0	0	0	0	0	0	1	OFFSET_3
\$YFFF4A	X	X	X	X	X	X	X	X	X	X	X	X	X	X	X	

OFFSET_1 = \$400, OFFSET_2 = \$7FFF, OFFSET_3 = (\$E000 - \$7FFF) = \$6001

8.2.2 Output Waveform

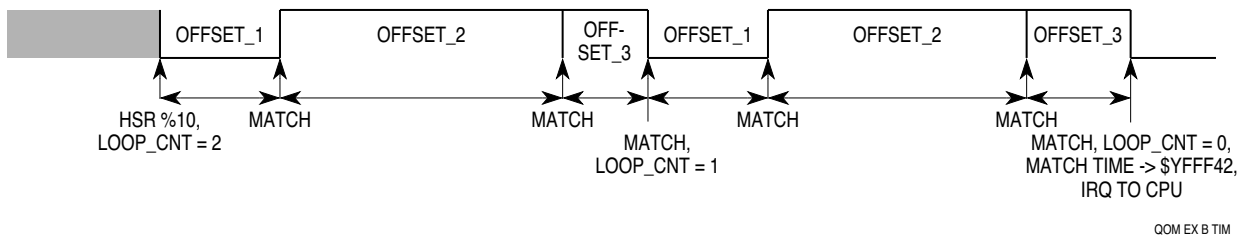

8.3 Example C

8.3.1 Description

Single-shot mode. Generates three edges (low, high, low) from a high start. Referenced to a time contained in parameter 2 of channel 6. First edge occurs \$1000 TCR1 clocks after reference, second edge occurs \$280 clocks after the first, and the third edge occurs \$3000 clocks after the second.

8.3.2 Initialization

Load parameter RAM as shown. Write HSR = %00, then issue HSR = %11 to initialize and start function.

Table 4 QOM Channel Parameter RAM

	15								8								0	
\$YFFF40	0	1	1	0	0	0	1	1	0	1	0	0	1	0	0	0	0	
\$YFFF42	X	X	X	X	X	X	X	X	0	0	0	0	0	0	0	0	0	
\$YFFF44	0	0	1	0	0	0	0	0	0	0	0	0	0	0	0	0	0	OFFSET_1
\$YFFF46	0	0	0	0	0	1	0	1	0	0	0	0	0	0	0	0	1	OFFSET_2
\$YFFF48	0	1	1	0	0	0	0	0	0	0	0	0	0	0	0	0	0	OFFSET_3
\$YFFF4A	X	X	X	X	X	X	X	X	X	X	X	X	X	X	X	X	X	

OFFSET_1 = \$1000, OFFSET_2 = \$280, OFFSET_3 = \$3000, REF_ADDR = \$62

8.3.3 Output Waveform

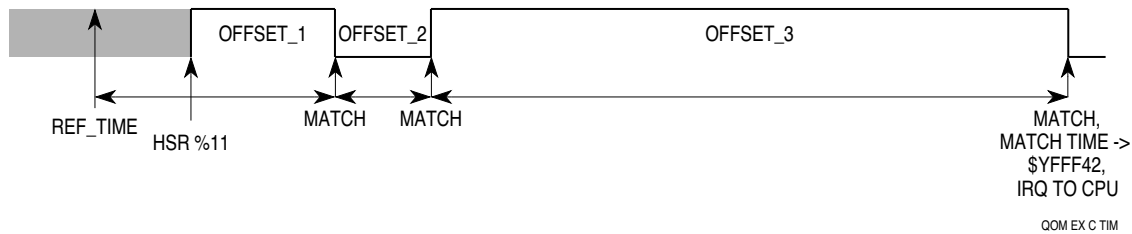

8.4 Example D

8.4.1 Description

Continuous mode. Generates active-high pulses with a high time of \$5100 TCR2 counts separated by a low time of \$2000 counts. Can effectively generate a PWM waveform if the offsets are varied.

8.4.2 Initialization

Load parameter RAM as shown. Write HSQ = %1X, then issue HSR = %10 to initialize and start function.

Table 5 QOM Channel Parameter RAM

	15	14	13	12	11	10	9	8	7	6	5	4	3	2	1	0	
\$YFFF40	X	X	X	X	X	X	X	0	0	1	0	0	0	1	1	1	
\$YFFF42	X	X	X	X	X	X	X	X	0	0	0	0	0	0	0	0	
\$YFFF44	0	1	0	0	0	0	0	0	0	0	0	0	0	0	0	1	OFFSET_1
\$YFFF46	1	0	1	0	0	0	1	0	0	0	0	0	0	0	0	0	OFFSET_2
\$YFFF48	X	X	X	X	X	X	X	X	X	X	X	X	X	X	X	X	
\$YFFF4A	X	X	X	X	X	X	X	X	X	X	X	X	X	X	X	X	

OFFSET_1 = \$2000, OFFSET_2 = \$5100

8.4.3 Output Waveform

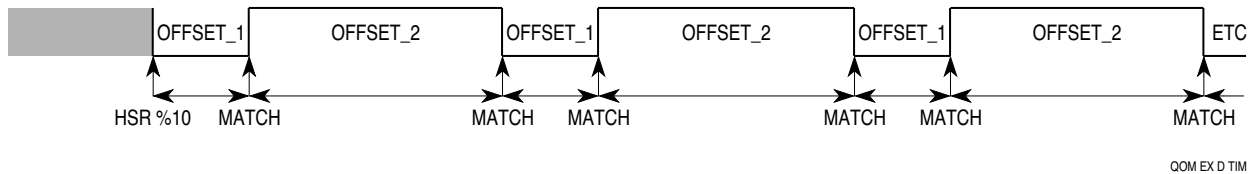

8.5 Example E

8.5.1 Description

Linked single-shot operation. Generates a single long pulse of \$15000 TCR1 counts duration, \$500 counts after a reference time contained in parameter 2 of channel 15. Initial pin condition remains the same as a previous condition. Uses three consecutive queue entries programmed for the same pin response to produce a match time greater than \$8000 TCR clocks.

8.5.2 Initialization

Load parameter RAM as shown. Write HSQ = %00, then issue HSR = %01 to initialize and start function.

Table 6 QOM Channel Parameter RAM

	15	8							0								
\$YFFF40	1	1	1	1	0	0	1	1	0	1	0	0	1	0	1	0	
\$YFFF42	X	X	X	X	X	X	X	X	1	X	X	X	X	X	X	0	
\$YFFF44	0	0	0	0	1	0	1	0	0	0	0	0	0	0	0	1	OFFSET_1
\$YFFF46	1	1	1	1	1	1	1	1	1	1	1	1	1	1	1	1	OFFSET_2
\$YFFF48	1	1	1	1	1	1	1	1	1	1	1	1	1	1	1	1	OFFSET_3
\$YFFF4A	1	0	1	0	0	0	0	0	0	0	0	0	0	0	1	0	OFFSET_4

OFFSET_1 = \$500, OFFSET_2 = \$7FFF, OFFSET_3 = \$7FFF, OFFSET_4 = \$5002

8.5.3 Output Waveform

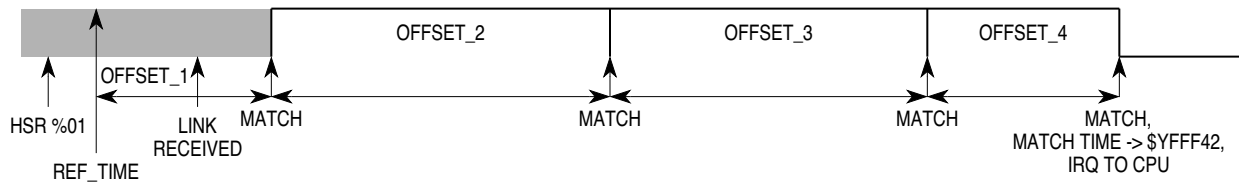

QOM EX E TIM

8.6 Example F

8.6.1 Description

Continuous mode. Shows special case where channel 15 is not used and channel 14 LAST_OFF_ADDR pointer points into channel 15 PRAM. The maximum number of edges possible (14 plus start condition) is shown. TCR1 is used as timebase.

8.6.2 Initialization

Load parameter RAM as shown below. Initialize function with HSQ = %1X, then issue HSR = %11.

Table 7 QOM Channel Parameter RAM

	15							8							0			
\$YFFFE0	X	X	X	X	X	X	X	0	1	1	1	1	1	1	1	1	0	
\$YFFFE2	X	X	X	X	X	X	X	X	0	0	0	0	0	0	0	0	0	
\$YFFFE4	0	0	0	0	0	0	1	0	0	0	0	0	0	0	0	0	0	OFFSET_1
\$YFFFE6	0	0	0	0	0	1	0	0	0	0	0	0	0	0	0	0	1	OFFSET_2
\$YFFFE8	0	0	0	0	0	1	1	0	0	0	0	0	0	0	0	0	0	OFFSET_3
\$YFFFEA	0	0	0	0	0	1	0	0	0	0	0	0	0	0	0	0	1	OFFSET_4
\$YFFFE C	0	0	0	0	0	0	1	0	0	0	0	0	0	0	0	0	0	OFFSET_5
\$YFFFE E	0	0	0	0	0	1	0	0	0	0	0	0	0	0	0	0	1	OFFSET_6
\$YFFFF0	0	0	0	0	0	1	0	0	0	0	0	0	0	0	0	0	0	OFFSET_7
\$YFFFF2	0	0	0	0	0	1	0	0	0	0	0	0	0	0	0	0	1	OFFSET_8
\$YFFFF4	0	0	0	0	0	0	1	0	0	0	0	0	0	0	0	0	0	OFFSET_9
\$YFFFF6	0	0	0	0	0	0	1	0	0	0	0	0	0	0	0	0	1	OFFSET_10
\$YFFFF8	0	0	0	0	0	0	1	0	0	0	0	0	0	0	0	0	0	OFFSET_11
\$YFFFFA	0	0	0	0	0	0	1	0	0	0	0	0	0	0	0	0	1	OFFSET_12
\$YFFFFC	0	0	0	0	0	0	1	0	0	0	0	0	0	0	0	0	0	OFFSET_13
\$YFFFFE	0	0	0	0	0	1	0	0	0	0	0	0	0	0	0	0	1	OFFSET_14

OFFSET_1, OFFSET_5, OFFSET_9, OFFSET_10, OFFSET_11, OFFSET_12, OFFSET_13 = \$0100
 OFFSET_2, OFFSET_4, OFFSET_6, OFFSET_7, OFFSET_8, OFFSET_14 = \$0200
 OFFSET_3 = \$0300

8.6.3 Output Waveform

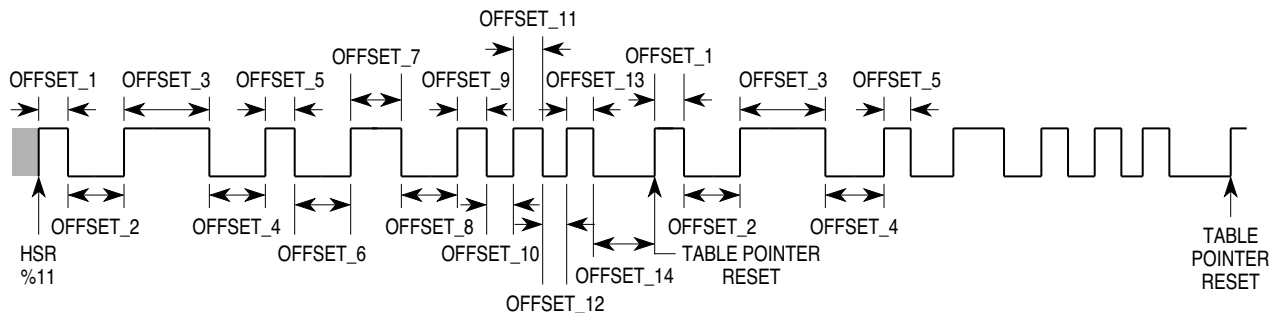

QOM EX F TIM

8.7 Example G

8.7.1 Description

Single-shot mode. Generates four active-high pulses of varying width. Uses TCR2 as timebase. Shows how the CPU can reload the queue to generate edges that are time-referenced to the previous sequence of matches. After the edge specified by OFFSET_4 has been generated, LAST_MATCH_TIM is written, the TPU requests interrupt service, and the function stops. The CPU reloads parameter RAM — offset values in the queue are changed, LOOP_CNT and OFF_PTR are reinitialized, and BIT_C is set — then issues HSR %01 to restart the function. The function is reconfigured, but pin state does not change, and the first match in the new sequence is referenced to the time of the last match (LAST_MATCH_TIM). The second sequence of match outputs flows smoothly from the first — if the CPU continues the process, an unbroken pulse train can be maintained.

8.7.2 Initialization

Load parameter RAM as shown below. Initialize function with HSQ = %00, then issue HSR = %10.

Table 8 QOM Channel Parameter RAM

	15								8								0	
\$YFFF40	X	X	X	X	X	X	X	0	0	1	0	0	1	0	1	1		
\$YFFF42	X	X	X	X	X	X	X	X	0	0	0	0	0	0	0	0		
\$YFFF44	0	0	0	0	0	1	0	0	0	0	0	0	0	0	0	0	1	OFFSET_1
\$YFFF46	0	0	0	0	1	1	0	0	0	0	0	0	0	0	0	0	0	OFFSET_2
\$YFFF48	0	0	0	0	0	1	0	0	0	0	0	0	0	0	0	0	1	OFFSET_3
\$YFFF4A	0	0	0	0	0	1	0	0	0	0	0	0	0	0	0	0	0	OFFSET_4

OFFSET_1, OFFSET_3, OFFSET_4 = \$0200
 OFFSET_2 = \$0600

8.7.3 PRAM Content After Completion of First Sequence

LOOP_CNT, OFF_PTR, and BIT_C have been overwritten by the LAST_MATCH_TIM value.

Table 9 QOM Channel Parameter RAM

	15								8								0	
\$YFFF40	X	X	X	X	X	X	X	0	0	1	0	0	1	0	1	1		
\$YFFF42	LAST_MATCH_TIM																	
\$YFFF44	0	0	0	0	0	1	0	0	0	0	0	0	0	0	0	0	1	OFFSET_1
\$YFFF46	0	0	0	0	1	1	0	0	0	0	0	0	0	0	0	0	0	OFFSET_2
\$YFFF48	0	0	0	0	0	1	0	0	0	0	0	0	0	0	0	0	1	OFFSET_3
\$YFFF4A	0	0	0	0	0	1	0	0	0	0	0	0	0	0	0	0	0	OFFSET_4

OFFSET_1, OFFSET_3, OFFSET_4 = \$0200
 OFFSET_2 = \$0600

8.7.4 Reload Queue

Load parameter RAM as shown below. Initialize function with HSQ = %00, then issue HSR = %01.

Table 10 QOM Channel Parameter RAM

	15	14	13	12	11	10	9	8	7	6	5	4	3	2	1	0	
\$YFFF40	X	X	X	X	X	X	X	0	0	1	0	0	1	0	1	1	OFFSET_1'
\$YFFF42	X	X	X	X	X	X	X	X	0	0	0	0	0	0	0	1	OFFSET_2'
\$YFFF44	0	0	0	0	1	1	0	0	0	0	0	0	0	0	0	1	OFFSET_3'
\$YFFF46	0	0	0	0	1	1	1	0	0	0	0	0	0	0	0	0	OFFSET_4'
\$YFFF48	0	0	0	0	0	1	0	0	0	0	0	0	0	0	0	1	OFFSET_3'
\$YFFF4A	0	0	0	0	1	1	0	0	0	0	0	0	0	0	0	0	OFFSET_4'

OFFSET_1', OFFSET_4' = \$0600
 OFFSET_2' = \$0700
 OFFSET_3' = \$0200

8.7.5 Output Waveform

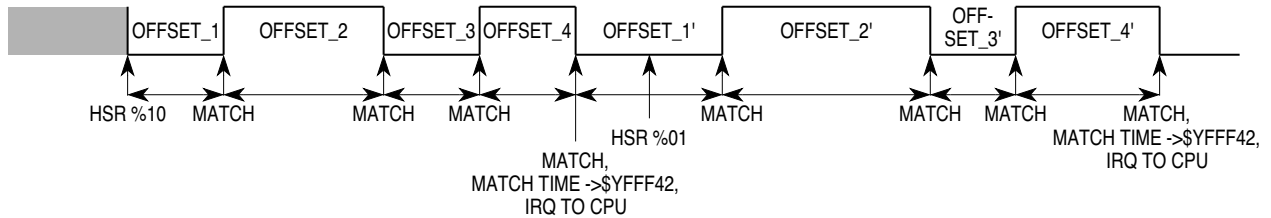

QOM EXG TIM

9 Queued Output Match Algorithm

The following description is provided as a guide only, to aid understanding of the function. The exact sequence of operations in microcode may be different to optimize speed and code size. TPU microcode source listings for all functions in the TPU function library can be downloaded from the Freescale Free-ware bulletin board. Refer to *Using the TPU Function Library and TPU Emulation Mode (TPUPN00/D)* for detailed instructions on downloading and compiling microcode.

The queued output match function consists of five states, which are described below. In the state descriptions, the phrases 'last match time' and 'last event time' refer to two different things. Match time is the value that is loaded into the match register. Event time is the value that is captured when a match occurs. In almost all cases, these values are the same. However, when a match register update results in an immediate match, the values differ. For example, if the current TCR value is \$6000 and \$5E00 is written into the match register, an immediate match occurs. Subsequently, 'last match time' is \$5E00, but 'last event time' is \$6000. Figure 6, which follows the state descriptions, is a state flow diagram of the QOM function. For clarity, reference is made to internal channel flags 0 and 1 in the following description. These are internal TPU control bits that are not available to the user.

9.1 STATE1 —QOM_HI

This state, entered as a result of HSR 11, performs initialization of the QOM function.

The channel pin is configured as an output

The pin state set high.

BIT_C is tested

If BIT_C = 0

An immediate match is generated and cleared to cancel any pending match

Flag1 is cleared

If BIT_C = 1

Flag1 is set

BIT_A is tested to determine the timebase for the match sequence

If BIT_A = 0

TCR1 is selected

If BIT_A = 1

TCR2 is selected

OFF_PTR is tested

If OFF_PTR ≠ 0

Link mode is selected

Channel flag0 is set

The TPU requests interrupt service from the CPU

The state ends

If OFF_PTR = 0

Channel flag0 is cleared

The first match is scheduled

OFF_PTR is initialized to point to OFFSET_1 (this overwrites BIT_C)

BIT_B and flag1 (BIT_C) are tested to determine reference time

%00 = Immediate TCR

%X1 = Last Event Time

%10 = Value pointed to by REF_ADDR

OFFSET_1 is right-shifted

The selected reference time is added to the shifted offset value

The sum is written to the match register

The value of OFFSET_1 bit0 is used to determine pin response to the scheduled match

The TPU requests interrupt service from the CPU

The state ends.

9.2 STATE2 — QOM_LO

This state is entered as a result of HSR 10. It is identical to STATE1 except that initial pin state is low.

9.3 STATE3 — QOM_NC

This state is entered as a result of HSR 01. It is identical to STATE1 except that initial pin state is unchanged from the previous state. Because STATE3 continues a previously-defined initial pin state, HSR 11 should not be used to initiate QOM operation unless it has been preceded by at least one sequence initiated by either HSR 01 or HSR 10.

9.4 STATE4 — QOM_LNK

STATE4 is entered in response to a link request from another TPU channel as long as channel flag0 is set.

BIT_A is tested to determine the timebase for the match sequence

If BIT_A = 0

TCR1 is selected

If BIT_A = 1

TCR2 is selected

The first match is scheduled

OFF_PTR is initialized to point to OFFSET_1 (this overwrites BIT_C)

BIT_B and flag1 (BIT_C) are tested to determine reference time

%00 = Immediate TCR

%X1 = Last Event Time

%10 = Value pointed to by REF_ADDR

OFFSET_1 is right-shifted one place

The selected reference time is added to the shifted offset value

The sum is written to the match register

The value of OFFSET_1 bit0 is used to determine pin response to the scheduled match

The TPU requests interrupt service from the CPU

The state ends.

9.5 STATE5 — QOM_M

This state is entered as a result of a match event on the QOM channel. Operation differs depending on the mode selected:

9.6 Single-Shot Mode

Queue pointer OFF_PTR is compared to LAST_OFF_ADDR

If OFF_PTR = LAST_OFF_ADDR

The last event time is stored in LAST_MATCH_TIM, overwriting LOOP_CNT and OFF_PTR.

The TPU requests interrupt service from the CPU

The state ends.

If OFF_PTR ≠ LAST_OFF_ADDR

OFF_PTR is incremented by 2 (word access)

The incremented OFF_PTR value is used to obtain the next match offset from the table

A new match is scheduled

The new offset value is right-shifted one place

The shifted offset value is added to the last match time

The sum is written to the match register

Bit0 of the offset parameter is used to determine pin response to the match

The state ends.

9.7 Loop Mode

Queue pointer OFF_PTR is compared to LAST_OFF_ADDR

If OFF_PTR = LAST_OFF_ADDR

OFF_PTR is reinitialized to point to OFFSET_1

LOOP_CNT is decremented.

LOOP_CNT is tested

If LOOP_CNT = 0

The last event time is stored in LAST_MATCH_TIM, overwriting LOOP_CNT and OFF_PTR.

The TPU requests interrupt service from the CPU

The state ends.

If LOOP_CNT ≠ 0

A new match is scheduled

The OFFSET_1 value is right-shifted one place

The shifted offset value is added to the last match time

The sum is written to the match register

Bit0 of the OFFSET_1 parameter is used to determine pin response to the match

The state ends.

If OFF_PTR ≠ LAST_OFF_ADDR

OFF_PTR is incremented by 2 (word access)

The incremented OFF_PTR value is used to obtain the next match offset from the queue

A new match is scheduled

The new offset value is right-shifted

The shifted offset value is added to the previous match time

The sum of match time and shifted offset value is written to the match register

Bit0 of the offset parameter is used to determine pin response to the scheduled match

The state ends.

9.8 Continuous Mode

Queue pointer OFF_PTR is compared to LAST_OFF_ADDR

If OFF_PTR = LAST_OFF_ADDR

OFF_PTR is reinitialized to point to OFFSET_1

A new match is scheduled

The OFFSET_1 value is right-shifted one place

The shifted offset value is added to the last match time

The sum is written to the match register

Bit0 of the OFFSET_1 parameter is used to determine pin response to the scheduled match

The state ends.

If OFF_PTR ≠ LAST_OFF_ADDR

OFF_PTR is incremented by 2 (word access)

The incremented OFF_PTR value is used to obtain the next match offset from the queue

A new match is scheduled

The new offset value is right-shifted

The shifted offset value is added to the previous match time

The sum of match time and shifted offset value is written to the match register

Bit0 of the offset parameter is used to determine pin response to the scheduled match

The state ends.

KEY:
 HSR1, HSR0, M/TSR, LSR, PIN, FLAG0 = %XXXXXX

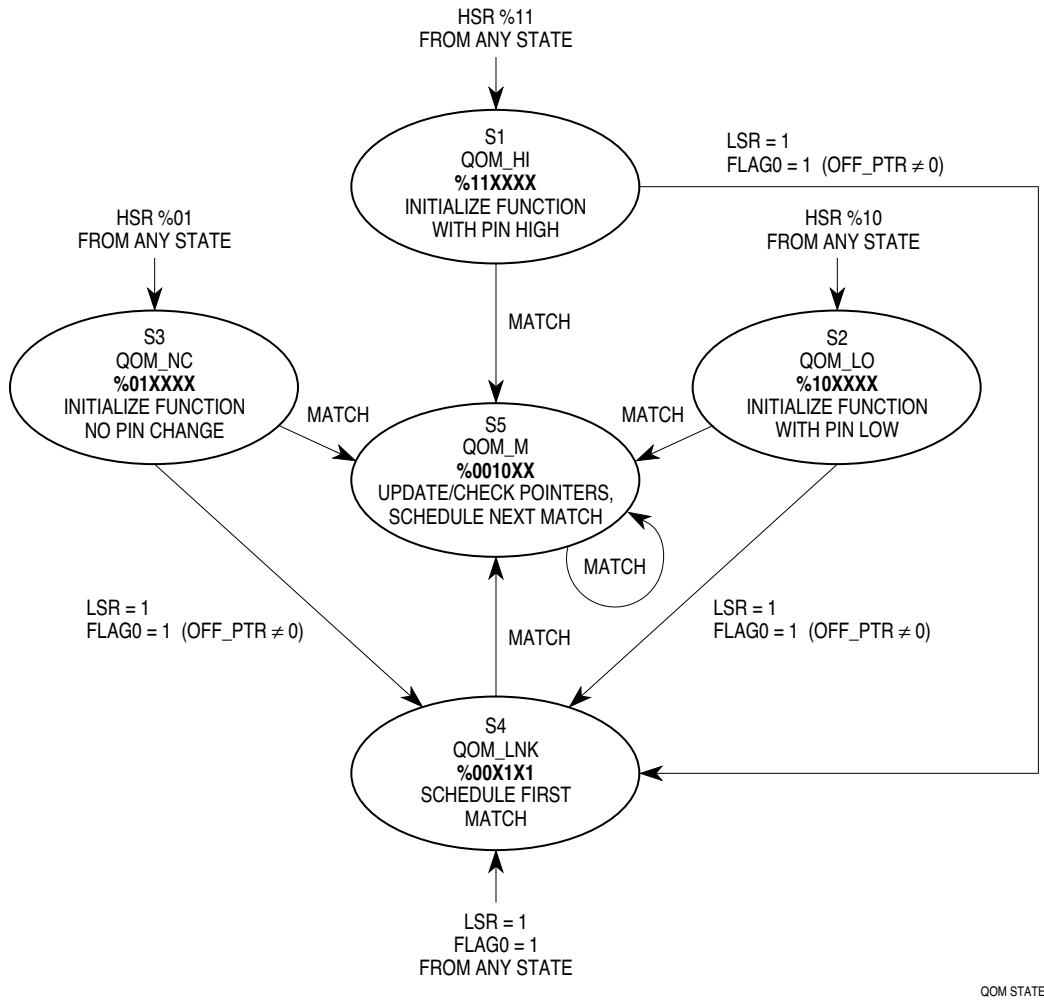

Figure 6 QOM Function State Flow Diagram

Freescale Semiconductor, Inc.

How to Reach Us:

Home Page:

www.freescale.com

E-mail:

support@freescale.com

USA/Europe or Locations Not Listed:

Freescale Semiconductor
Technical Information Center, CH370
1300 N. Alma School Road
Chandler, Arizona 85224
+1-800-521-6274 or +1-480-768-2130
support@freescale.com

Europe, Middle East, and Africa:

Freescale Halbleiter Deutschland GmbH
Technical Information Center
Schatzbogen 7
81829 Muenchen, Germany
+44 1296 380 456 (English)
+46 8 52200080 (English)
+49 89 92103 559 (German)
+33 1 69 35 48 48 (French)
support@freescale.com

Japan:

Freescale Semiconductor Japan Ltd.
Headquarters
ARCO Tower 15F
1-8-1, Shimo-Meguro, Meguro-ku,
Tokyo 153-0064
Japan
0120 191014 or +81 3 5437 9125
support.japan@freescale.com

Asia/Pacific:

Freescale Semiconductor Hong Kong Ltd.
Technical Information Center
2 Dai King Street
Tai Po Industrial Estate
Tai Po, N.T., Hong Kong
+800 2666 8080
support.asia@freescale.com

For Literature Requests Only:

Freescale Semiconductor Literature Distribution Center
P.O. Box 5405
Denver, Colorado 80217
1-800-441-2447 or 303-675-2140
Fax: 303-675-2150
LDCForFreescaleSemiconductor@hibbertgroup.com

Information in this document is provided solely to enable system and software implementers to use Freescale Semiconductor products. There are no express or implied copyright licenses granted hereunder to design or fabricate any integrated circuits or integrated circuits based on the information in this document. Freescale Semiconductor reserves the right to make changes without further notice to any products herein. Freescale Semiconductor makes no warranty, representation or guarantee regarding the suitability of its products for any particular purpose, nor does Freescale Semiconductor assume any liability arising out of the application or use of any product or circuit, and specifically disclaims any and all liability, including without limitation consequential or incidental damages. "Typical" parameters which may be provided in Freescale Semiconductor data sheets and/or specifications can and do vary in different applications and actual performance may vary over time. All operating parameters, including "Typicals" must be validated for each customer application by customer's technical experts. Freescale Semiconductor does not convey any license under its patent rights nor the rights of others. Freescale Semiconductor products are not designed, intended, or authorized for use as components in systems intended for surgical implant into the body, or other applications intended to support or sustain life, or for any other application in which the failure of the Freescale Semiconductor product could create a situation where personal injury or death may occur. Should Buyer purchase or use Freescale Semiconductor products for any such unintended or unauthorized application, Buyer shall indemnify and hold Freescale Semiconductor and its officers, employees, subsidiaries, affiliates, and distributors harmless against all claims, costs, damages, and expenses, and reasonable attorney fees arising out of, directly or indirectly, any claim of personal injury or death associated with such unintended or unauthorized use, even if such claim alleges that Freescale Semiconductor was negligent regarding the design or manufacture of the part.



**For More Information On This Product,
Go to: www.freescale.com**