

Position-Synchronized Pulse Generator (PSP) TPU Function

By Sharon Darley

1 Functional Overview

The PSP function can generate an output transition that is referenced to a time previously determined by another channel. Typically, this function is used with a PMM or PMA function on another channel. The PMM/PMA function determines the reference time, and the PSP function generates the output pulse in relation to that reference time. The PSP function has two operating modes: angle-angle and angle-time. In angle-angle mode, the rising and falling edges of the output pulse are determined independently of each other. In angle-time mode, the falling edge of the output pulse is determined in reference to the rising edge.

Up to 15 PSP function channels may operate with a single input reference channel executing a PMA or PMM function. The input channel measures and stores the time period between the flywheel teeth and resets TCR2 when the engine reaches top dead center. The PSP output channel uses the most recent period calculated by the input channel to project output transitions at specific engine degrees. Since the flywheel teeth might be 30 or more degrees apart, a fractional multiply resolves down to the precise angle.

NOTE

The PSP function was developed to work in conjunction with the PMA and PMM functions. The programming notes for these functions (TPUPN15A/D and TPUPN15B/D, respectively) should be consulted when using the PSP function.

2 Detailed Description

The PSP function is typically used in automotive applications with a PMM or PMA function on another channel. An optical or magnetic sensor is connected to both a channel executing the PMM/PMA function and the clock input to TCR2. Connecting the sensor to the TCR2 clock allows engine-cycle position to be mapped into TCR2 counts. The sensor detects the teeth on a flywheel. The flywheel has regularly spaced teeth with the exception of one or more reference points in the form of missing or additional teeth. The PMM or PMA function detects these reference points. The PSP function then generates an output pulse in relation to the desired reference points.

Once initialized and synchronized to the input pulse sequence, a PSP function continually generates output pulses based on the angle and ratio parameters. To generate the output pulse, the CPU updates the angle and ratio parameters. The parameters ANGLE1/RATIO1 and ANGLE2/RATIO2 must be written coherently if both are changed, since they are used together. If changes are made by long word move instructions, coherency is assured. When changes are made with an immediate update request (HSR = 01), host sequence bit 1 determines which parameters are used for pulse generation.

If host sequence bit 1 is zero, all parameters are used coherently and immediately if the pin is low and TCR2 is still less than ANGLE1. If host sequence bit 1 is one, only the falling edge is changed immediately. As each transition is generated, an interrupt request may be asserted. The PSP function has two modes for determining pulse length: angle-angle mode and angle-time mode. Angle-angle mode determines the falling edge of the pulse by angular position, while angle-time mode determines the falling edge of the pulse in reference to the rising edge.



In angle-angle mode (host sequence bit 0 equals zero), the parameters ANGLE1, ANGLE2, RATIO1, and RATIO2 are used to calculate the rising and falling output transitions. ANGLE1 is the reference angle, or tooth number, on the flywheel that determines the rising output transition. ANGLE2 is the reference angle, or tooth number, on the flywheel that determines the falling output transition. The output pulse is generated as follows. When TCR2 (which is clocked by the input pulse train from the flywheel) reaches the position indicated by ANGLE1, the value in RATIO1 is multiplied by the period pointed to by PERIOD_ADDRESS to determine the projected time for the rising edge. (The period referenced by PERIOD_ADDRESS is typically generated by a PMA/PMM function on another channel.) A similar sequence occurs for the falling-edge computation, using RATIO2, when TCR2 matches the value in ANGLE2. Each ratio parameter has an effective range of zero to $(2 - 2^{-8})$ that allows the TPU to project up to two times the previously calculated period. The lower seven bits of these parameters are used in a fractional multiply; hence, the edge can be projected to an accuracy of 1/128 of the input period. Figure 1 illustrates the relationship between the parameters and includes a special case where ANGLE1 equals ANGLE2.

CASE 1: ANGLE1 \neq ANGLE2

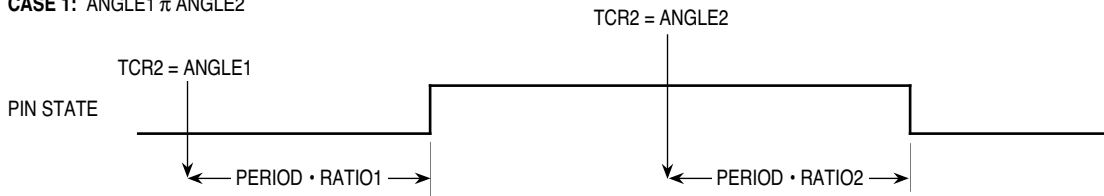

CASE 2: ANGLE1 = ANGLE2

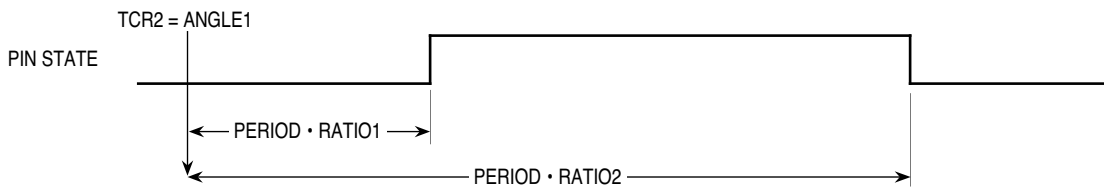

1041A

Figure 1 PSP Angle-Angle Mode

In angle-time mode (host sequence bit 0 equals one), ANGLE1, RATIO1, and HIGH_TIME are the parameters used to calculate the rising and falling edges of the output pulse. ANGLE1 is the reference angle, or tooth number, on the flywheel that determines the rising output transition. HIGH_TIME is the time duration of the pulse. The output pulse is generated as follows. When TCR2 (which is clocked by the input pulse train from the flywheel) reaches the position indicated by ANGLE1, the value in RATIO1 is multiplied by the period pointed to by PERIOD_ADDRESS to determine the projected time for the rising edge. (The period referenced by PERIOD_ADDRESS is typically generated by a PMA/PMM function on another channel.) The falling edge is then delayed from the rising edge by the amount of time specified in HIGH_TIME. Figure 2 illustrates the relationship between these parameters.

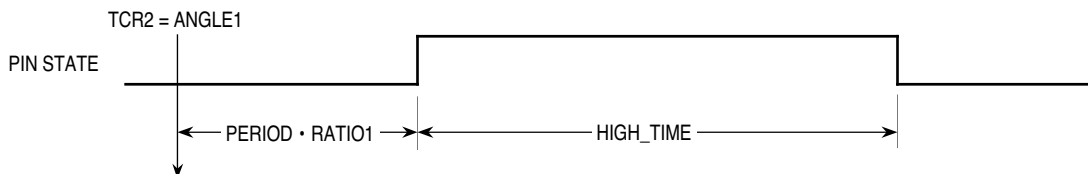

1042A

Figure 2 PSP Angle-Time Mode

During normal operation, the TPU generates an output pulse based on the angle and ratio parameters. To control the output pulse, the CPU updates the angle and ratio parameters. The parameter sets ANGLE1/RATIO1 and ANGLE2/RATIO2 must be written coherently (i.e. by long-word writes) if both are changed, since they are used together.

The PSP function uses force mode when an error from the input channel requires the CPU to manipulate the output pin directly. An error occurs if the period is too long to be measured, or if the input channel tracking the flywheel teeth is out of synchronization. In this case, the CPU updates CHANNEL_CONTROL appropriately and issues a host service request, forcing the TPU to assert or negate the output pin and to stop any other pin activity. Reinitializing the time function (to be performed only when the pin is low) causes a return to normal operation.

PSP is often used with the PMA and PMM functions, generating pulses synchronized to the period and position of teeth measured by these functions. Refer to the programming notes for these two functions for examples illustrating the use of PSP with PMA and PMM.

3 Function Code Size

Total TPU function code size determines what combination of functions can fit into a given ROM or emulation memory microcode space. PSP function code size is:

$$88 \mu \text{ instructions} + 14 \text{ entries} = \mathbf{102 \text{ long words}}$$

4 Function Parameters

This section provides detailed descriptions of PSP function parameters stored in channel parameter RAM. **Figure 3** shows TPU parameter RAM address mapping. **Figure 4** shows the parameter RAM assignment used by the PSP function. In the diagrams, Y = M111, where M is the value of the module mapping bit (MM) in the system integration module configuration register (Y = \$7 or \$F).

Channel Number	Base Address	Parameter Address							
		0	1	2	3	4	5	6	7
0	\$YFFF##	00	02	04	06	08	0A	—	—
1	\$YFFF##	10	12	14	16	18	1A	—	—
2	\$YFFF##	20	22	24	26	28	2A	—	—
3	\$YFFF##	30	32	34	36	38	3A	—	—
4	\$YFFF##	40	42	44	46	48	4A	—	—
5	\$YFFF##	50	52	54	56	58	5A	—	—
6	\$YFFF##	60	62	64	66	68	6A	—	—
7	\$YFFF##	70	72	74	76	78	7A	—	—
8	\$YFFF##	80	82	84	86	88	8A	—	—
9	\$YFFF##	90	92	94	96	98	9A	—	—
10	\$YFFF##	A0	A2	A4	A6	A8	AA	—	—
11	\$YFFF##	B0	B2	B4	B6	B8	BA	—	—
12	\$YFFF##	C0	C2	C4	C6	C8	CA	—	—
13	\$YFFF##	D0	D2	D4	D6	D8	DA	—	—
14	\$YFFF##	E0	E2	E4	E6	E8	EA	EC	EE
15	\$YFFF##	F0	F2	F4	F6	F8	FA	FC	FE

— = Not Implemented (reads as \$00)

Figure 3 TPU Channel Parameter RAM CPU Address Map

	15	14	13	12	11	10	9	8	7	6	5	4	3	2	1	0
\$YFFFW0	PERIOD_ADDRESS								CHANNEL_CONTROL							
\$YFFFW2	R2_A2_TEMP															
\$YFFFW4	ANGLE_TIME															
\$YFFFW6	RATIO_TEMP															
\$YFFFW8	RATIO1								ANGLE1							
\$YFFFWA	RATIO2/HIGH_TIME								ANGLE2/HIGH_TIME							

W = Channel number

Parameter Write Access:

	Written by CPU
	Written by TPU
	Written by CPU and TPU
	Unused parameters

Figure 4 PSP Function Parameter RAM Assignment

4.1 CHANNEL_CONTROL

CHANNEL_CONTROL determines the pin state in force mode only, and configures the PSC, PAC, and TBS fields. The PSC field forces the output level of the pin directly without affecting the PAC latches. The PSP function does not use the PAC and TBS fields. The table below defines the allowable data for this parameter.

	15	14	13	12	11	10	9	8	7	6	5	4	3	2	1	0
	NOT USED						TBS				PAC			PSC		

Table 1 PSP CHANNEL_CONTROL Options

TBS	PAC	PSC	Action	
8 7 6 5	4 3 2	1 0	Input Channel	Output Channel
		0 1 1 0	— —	Force Pin High Force Pin Low
	0 0 0 1 x x		Do Not Detect Transition Do Not Change PAC	Do Not Change Pin State on Match Do Not Change PAC
1 x x x			Do Not Change TBS	Do Not Change TBS

4.2 PERIOD_ADDRESS

PERIOD_ADDRESS is a byte parameter that is updated by the CPU and contains the address of a period parameter, usually located in a channel executing a PMA/PMM function. In this case, the address should be that of PERIOD_LOW_WORD.

4.3 R2_A2_TEMP

R2_A2_TEMP is used to temporarily store the value of ANGLE2 and RATIO2 during pulse generation, to guarantee coherency of ANGLE1, ANGLE2, RATIO1, and RATIO2. ANGLE2 and RATIO2 are copied to R2_A2_TEMP when a match on ANGLE1 is set up.

4.4 ANGLE_TIME

ANGLE_TIME is updated continuously by the TPU with the TCR1 value. In angle-angle mode, ANGLE_TIME contains the TCR1 value that occurs when TCR2 equals ANGLE1. In angle-time mode, ANGLE_TIME contains the TCR1 value associated with the low-to-high transition.

4.5 RATIO_TEMP

RATIO_TEMP is a temporary variable used by the TPU to store the value of ANGLE1 and RATIO1 during pulse generation. This parameter is used to guarantee coherent access to ANGLE1 and RATIO1.

4.6 RATIO1

RATIO1 contains an 8-bit multiplier for the rising output transition. This parameter is updated by the CPU. The range of RATIO1 is \$00 to \$FF (0_{10} to 1.99_{10}).

NOTE

If RATIO1 equals zero (or is very small), the rising edge of the pulse is skewed and the amount of skew is dependent upon TPU latency. Updating ANGLE1 to the previous angle and adjusting RATIO1 appropriately eliminates this problem.

4.7 ANGLE1

ANGLE1 is a byte parameter updated by the CPU and contains the reference angle of TCR2 for the rising output transition.

4.8 RATIO2

RATIO2 contains an 8-bit multiplier for the falling output transition. This parameter is updated by the CPU and is used only in angle-angle mode. The range of RATIO2 is \$00 to \$FF (0_{10} to 1.99_{10}).

NOTE

If RATIO2 equals zero (or is very small), the falling edge of the pulse is skewed and the amount of skew is dependent upon TPU latency. Updating ANGLE2 to the previous angle and adjusting RATIO2 appropriately eliminates this problem.

4.9 ANGLE2

ANGLE2 is a byte parameter updated by the CPU. This parameter contains the reference angle of TCR2 for the falling output transition and is used only in angle-angle mode.

4.10 HIGH_TIME

HIGH_TIME specifies the time duration of the output pulse in angle-time mode. The weighting of the least significant bit of this parameter is defined as equal to the least significant bit of TCR1. This parameter is updated by the CPU and is used only in angle-time mode.

5 Host Interface to Function

This section provides information concerning the TPU host interface to the PSP function. **Figure 5** is a TPU address map. Detailed TPU register diagrams follow the figure. In the diagrams, $Y = M111$, where M is the value of the module mapping bit (MM) in the system integration module configuration register ($Y = \$7$ or $\$F$).

Address	15	8	7	0
\$YFFE00	TPU MODULE CONFIGURATION REGISTER (TPUMCR)			
\$YFFE02	TEST CONFIGURATION REGISTER (TCR)			
\$YFFE04	DEVELOPMENT SUPPORT CONTROL REGISTER (DSCR)			
\$YFFE06	DEVELOPMENT SUPPORT STATUS REGISTER (DSSR)			
\$YFFE08	TPU INTERRUPT CONFIGURATION REGISTER (TICR)			
\$YFFE0A	CHANNEL INTERRUPT ENABLE REGISTER (CIER)			
\$YFFE0C	CHANNEL FUNCTION SELECTION REGISTER 0 (CFSR0)			
\$YFFE0E	CHANNEL FUNCTION SELECTION REGISTER 1 (CFSR1)			
\$YFFE10	CHANNEL FUNCTION SELECTION REGISTER 2 (CFSR2)			
\$YFFE12	CHANNEL FUNCTION SELECTION REGISTER 3 (CFSR3)			
\$YFFE14	HOST SEQUENCE REGISTER 0 (HSQR0)			
\$YFFE16	HOST SEQUENCE REGISTER 1 (HSQR1)			
\$YFFE18	HOST SERVICE REQUEST REGISTER 0 (HSRR0)			
\$YFFE1A	HOST SERVICE REQUEST REGISTER 1 (HSRR1)			
\$YFFE1C	CHANNEL PRIORITY REGISTER 0 (CPR0)			
\$YFFE1E	CHANNEL PRIORITY REGISTER 1 (CPR1)			
\$YFFE20	CHANNEL INTERRUPT STATUS REGISTER (CISR)			
\$YFFE22	LINK REGISTER (LR)			
\$YFFE24	SERVICE GRANT LATCH REGISTER (SGLR)			
\$YFFE26	DECODED CHANNEL NUMBER REGISTER (DCNR)			

Figure 5 TPU Address Map

CIER — Channel Interrupt Enable Register

\$YFFE0A

15	14	13	12	11	10	9	8	7	6	5	4	3	2	1	0
CH 15	CH 14	CH 13	CH 12	CH 11	CH 10	CH 9	CH 8	CH 7	CH 6	CH 5	CH 4	CH 3	CH 2	CH 1	CH 0

CH	Interrupt Enable
0	Channel interrupts disabled
1	Channel interrupts enabled

CFSR[0:3] — Channel Function Select Registers

\$YFFE0C – \$YFFE12

15	14	13	12	11	10	9	8	7	6	5	4	3	2	1	0
CFS (CH 15, 11, 7, 3)				CFS (CH 14, 10, 6, 2)				CFS (CH 13, 9, 5, 1)				CFS (CH 12, 8, 4, 0)			

CFS[4:0] — Function Number (Assigned during microcode assembly)

HSQR[0:1] — Host Sequence Registers

\$YFFE14 – \$YFFE16

15	14	13	12	11	10	9	8	7	6	5	4	3	2	1	0
CH 15, 7		CH 14, 6		CH 13, 5		CH 12, 4		CH 11, 3		CH 10, 2		CH 9, 1		CH 8, 0	

CH[15:0]	Action Taken
x0	Angle-Angle Mode Output specified by ANGLE1, ANGLE2, RATIO1, RATIO2.
x1	Angle-Time Mode Output pulse specified by ANGLE1, RATIO 1, and HIGH_TIME.
0x	ANGLE1 and ANGLE2/HIGH_TIME are used if pin is low and TCR2 < ANGLE1, else nothing is done until next pulse.
1x	ANGLE2/HIGH_TIME is used when immediate request is issued if pin has not fallen.

HSRR[0:1] — Host Service Request Registers

\$YFFE18 – \$YFFE1A

15	14	13	12	11	10	9	8	7	6	5	4	3	2	1	0
CH 15, 7		CH 14, 6		CH 13, 5		CH 12, 4		CH 11, 3		CH 10, 2		CH 9, 1		CH 8, 0	

CH[15:0]	Initialization
00	No Host Service (Reset Condition)
01	Immediate Update
10	Initialization (<i>Init</i>)
11	Force Mode

CPR[1:0] — Channel Priority Registers

\$YFFE1C – \$YFFE1E

15	14	13	12	11	10	9	8	7	6	5	4	3	2	1	0
CH 15, 7		CH 14, 6		CH 13, 5		CH 12, 4		CH 11, 3		CH 10, 2		CH 9, 1		CH 8, 0	

CH[15:0]	Channel Priority
00	Disabled
01	Low
10	Middle
11	High

CISR — Channel Interrupt Status Register

\$YFFE20

15	14	13	12	11	10	9	8	7	6	5	4	3	2	1	0
CH 15	CH 14	CH 13	CH 12	CH 11	CH 10	CH 9	CH 8	CH 7	CH 6	CH 5	CH 4	CH 3	CH 2	CH 1	CH 0

CH	Interrupt Status
0	Channel interrupt not asserted
1	Channel interrupt asserted

6 Function Configuration

The CPU initializes this time function by the following:

1. Writing parameter PERIOD_ADDRESS;
2. Writing parameters ANGLE1/RATIO1 and ANGLE2/RATIO2 (angle-angle mode) or ANGLE1/RATIO1 and HIGH_TIME (angle-time mode);
3. Writing host sequence bit 0 according to mode of operation;
4. Issuing an HSR %10 for initialization; and
5. Enabling channel servicing by assigning a high, middle, or low priority.

The TPU then executes initialization. The CPU should monitor the HSR register (or the channel interrupt) until the TPU clears the service request to 00 before changing any parameters or before issuing a new service request to this channel.

The CHANNEL_CONTROL parameter is not needed for host initialization (HSRR = %10). In this case, microcode forces the channel hardware to match on TCR2, capture TCR1, and force the pin low. The CHANNEL_CONTROL parameter is only used by the Host Service 'Force Mode', (HSRR = %11).

The following general rules apply to updated ANGLE1, RATIO1, ANGLE2, and RATIO2 values during pulse generation:

1. When ANGLE1 is less than or equal to ANGLE2, the new values of these parameters are used coherently to generate pulses scheduled after a special tooth condition that results in TCR2 being reset (to \$FFFF).



Figure 6 Updated Parameters When ANGLE1 ≤ ANGLE2

2. When ANGLE1 is greater than ANGLE2, the new values of these parameters are used coherently to generate pulses scheduled after the subsequent falling transition.

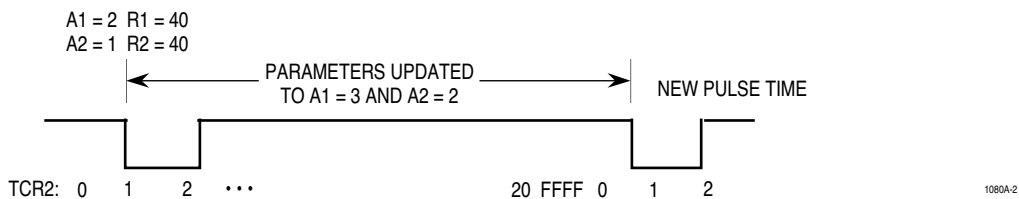

Figure 7 Updated Parameters When ANGLE1 > ANGLE2

- To cause an immediate update in the output pulse, the parameters should be updated, host sequence bit 1 set appropriately, and an immediate update request issued. If host sequence bit 1 is set to one, only the new ANGLE2 and RATIO2 are used. If host sequence bit 1 is set to zero, the new ANGLE1, ANGLE2, RATIO1, and RATIO2 are used coherently.

If the pin is low when an immediate request is executed, one of the following results:

- If host sequence bit 1 = 1, only the next falling transition is changed; or
- If host sequence bit 1 = 0 and TCR2 is less than ANGLE1, both the rising and falling transitions are changed; or
- Nothing is done.

If the pin is high when an immediate request is executed, one of the following results:

- If host sequence bit 1 = 1, only the next falling transition is changed; or
- Nothing is done.

Following are three special cases of abnormal output pulses:

CASE 1:

In angle-time mode, if the falling edge of the PSP output pulse occurs before the rising edge of

ANGLE1 + 1, then a short stream of pulses will be generated instead of just one pulse. An illustration of this phenomenon is shown in **Figure 8**.

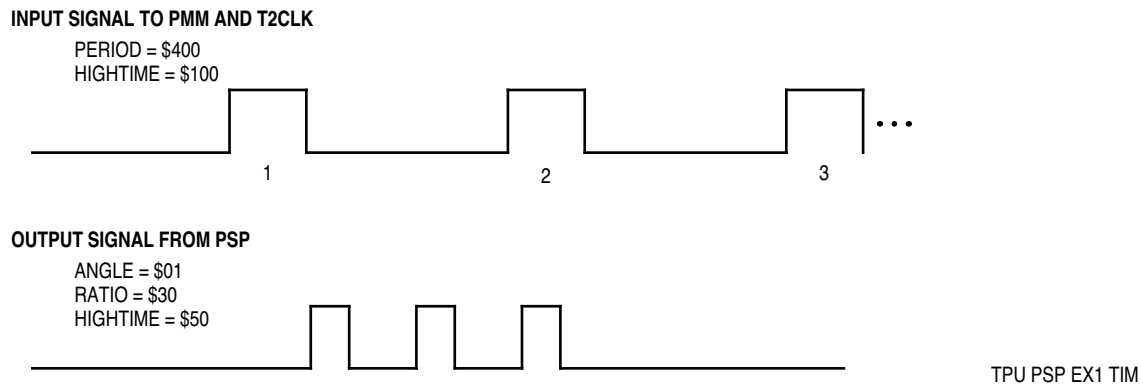

Figure 8 Example for Case 1

This continuous stream is generated because TCR2 continues to match ANGLE1 until the rising edge of the next tooth is reached. To avoid producing a stream of pulses, use the previous angle and a larger value in RATIO1 to determine the rising edge of the output pulse. Thus, in this example, use ANGLE1 = \$0 instead of ANGLE1 = \$01 and adjust RATIO1 to attain the desired pulse position, or use angle-angle mode.

CASE 2:

In angle-angle mode, if ANGLE2 = ANGLE1 + 1 and RATIO1 is greater than \$80, the pulse width will be longer than expected. RATIO1 = \$80 occurs at the point when the rising edge of the output pulse is at the rising edge of TCR2 = ANGLE2. The larger the RATIO1 value is, the longer the pulse width will be. At RATIO1 = RATIO2 = \$FF, the pulse width will be twice as long as expected. Figure 9 illustrates the case when RATIO1 < \$80 and also the case when RATIO1 > \$80.

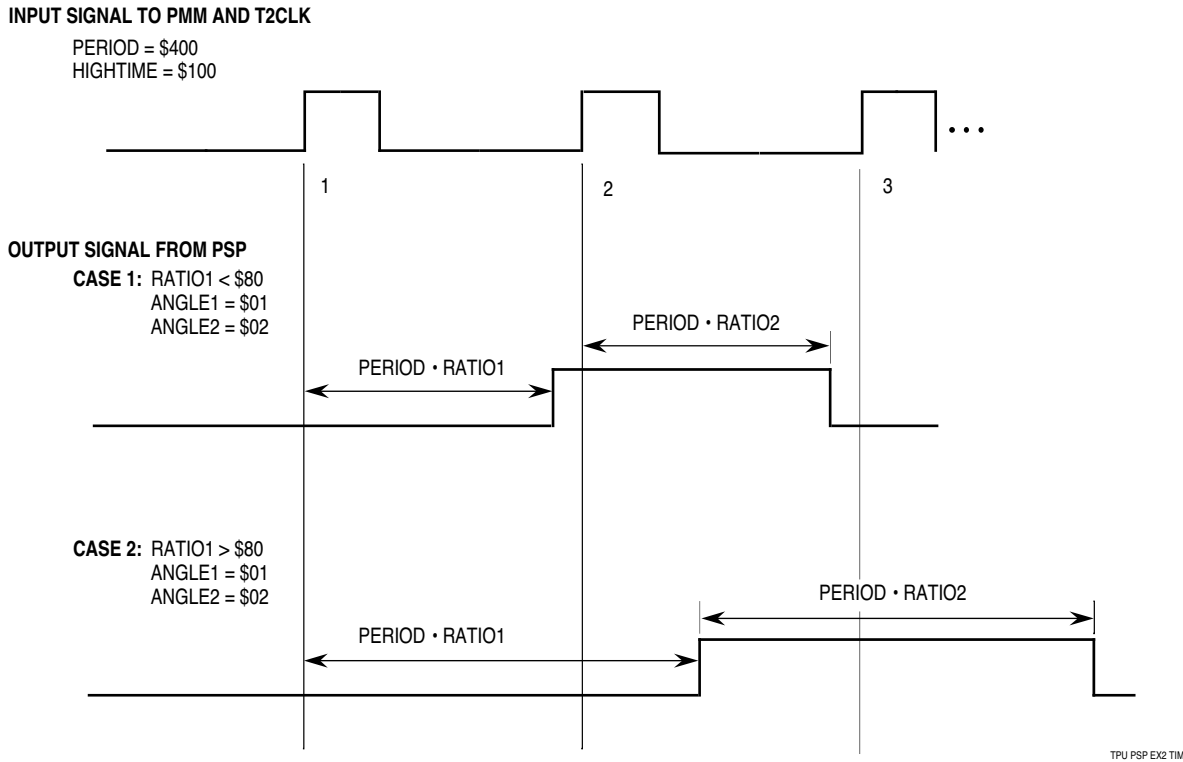

Figure 9 Example for Case 2

This phenomenon occurs because of the way the output signal is generated. First, $TCR2 = ANGLE1$ matches. Then, the rising edge is calculated. Next, after the low-to-high pin transition takes place, $TCR2 = ANGLE2$ matches. Then, the falling edge is calculated. The falling edge is offset from the $TCR1$ time of the $TCR2 = ANGLE2$ match by the product of the reference period at $PERIOD_ADDRESS$ and $RATIO2$. The TPU cannot match $TCR2 = ANGLE2$ and calculate the falling edge until the rising edge has taken place. Thus, if the rising edge occurs after time $TCR2 = ANGLE2$, the TPU will immediately generate a match, and the reference used will be the $TCR1$ value just after the rising edge of the pulse, instead of the $TCR1$ value of $ANGLE2$. Thus, the falling edge will be referenced to the rising edge, rather than to $ANGLE2$.

In summary, for values of $0 \leq RATIO1 \leq \$80$, the falling edge is referenced to the sensor tooth at $ANGLE1$. For values of $\$80 < RATIO1 \leq \FF , the falling edge is referenced approximately to the rising edge. If $\$80 < RATIO1 \leq \FF , use $ANGLE1 = ANGLE2$ with a larger $RATIO2$ value to avoid the extended pulse width.

CASE 3:

If the hightime of an output pulse is so long that the falling edge occurs after the next scheduled rising edge, the next pulse will not be generated.

7 Performance and Use of Function

7.1 Performance

Like all TPU functions, PSP function performance in an application is to some extent dependent upon the service time (latency) of other active TPU channels. This is due to the operational nature of the scheduler. The more TPU channels are active, the more performance decreases. Worst-case latency in any TPU application can be closely estimated. To analyze the performance of an application that appears to approach the limits of the TPU, use the guidelines given in the *TPU Reference Manual* (TPURM/AD) and the information in the following table.

Table 2 PSP State Timing

State Name	Clock Cycles Angle-Angle Mode	RAM Accesses Angle-Angle Mode	Clock Cycles Angle-Time Mode	RAM Accesses Angle-Time Mode
S1 <i>Init</i>	16	4	16	4
S2 <i>Trans_H_L</i>	30	3	24	5
S3 <i>Angle1_gt_8000</i>	20	4	20	4
S4 <i>TCR2_eq_Angle1</i>	50	4	50	3
S5 <i>Ratio1_gt_8000</i>	8	1	8	1
S6 <i>Trans_L_H</i> Angle 1 ≠ Angle 2 Angle 1 = Angle 2	32 70	4 6	18 —	2 —
S7 <i>Angle1_gt_Angle2</i>	12	3	—	—
S8 <i>TCR2_eq_Angle2</i>	44	3	—	—
S9 <i>Ratio2_gt_8000</i>	10	1	10	1
S10 <i>Immed_L</i>	18	5	18	5
S11 <i>Immed_H</i> A1 ≠ A2 A1 = A2	26 76	3 6	30 —	4 —
S12 <i>Force</i>	6	1	6	1

7.2 Changing Mode

The host sequence bits are used to select PSP function operating mode. Change host sequence bit values only when the function is stopped or disabled (channel priority bits = %00). Disabling the channel before changing mode avoids conditions that cause indeterminate operation.

8 Function Examples

8.1 Example A

8.1.1 Description

A common application of the PSP function is an angle-based automotive engine control system. A typical system is shown in **Figure 10**. As shown in this illustration, the flywheel has reference points in the form of missing or additional teeth. The PMM/PMA functions can be used to detect these reference points; the PMM function detects missing teeth, and the PMA function detects additional teeth.

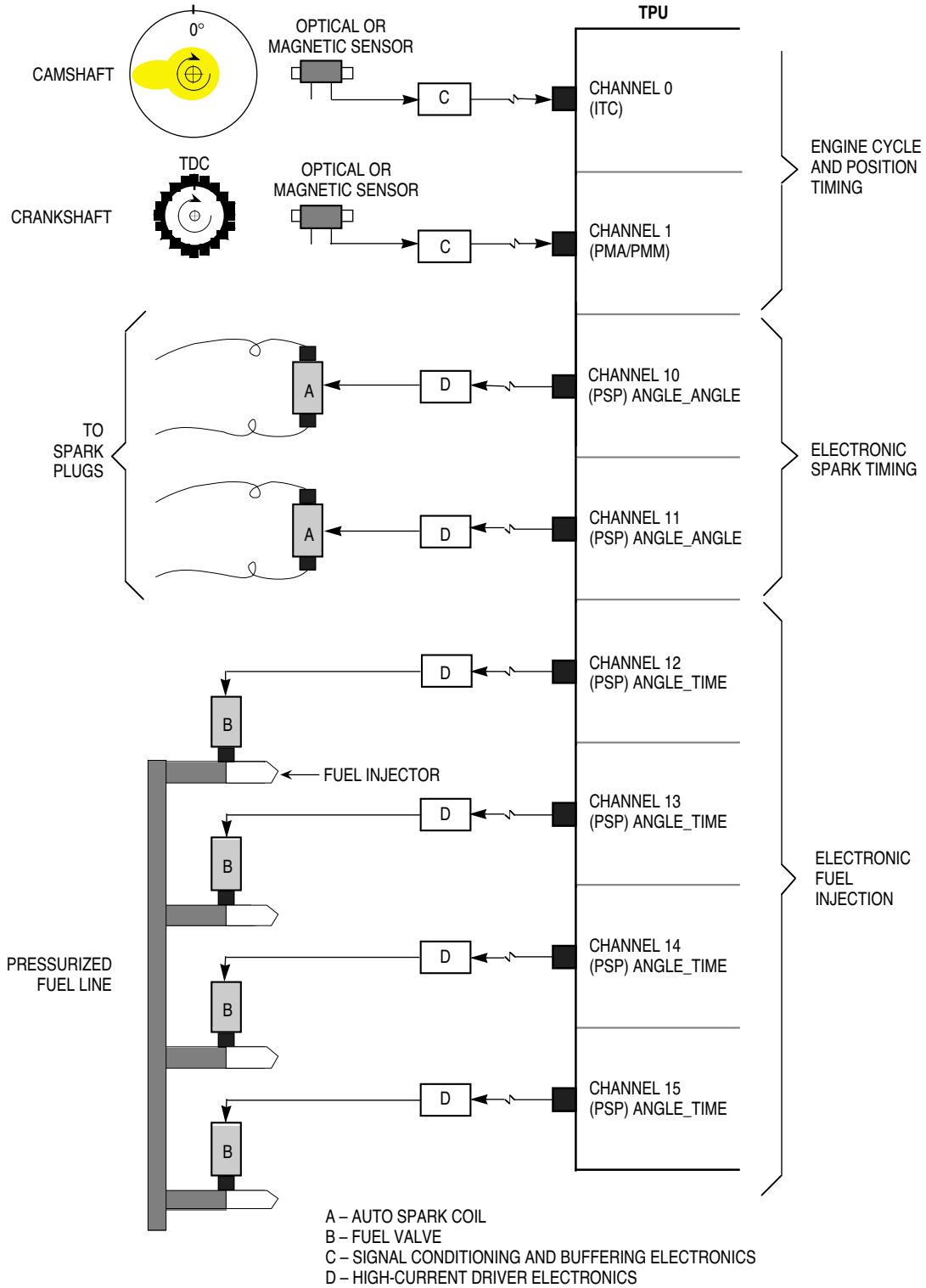

1008A

Figure 10 Engine Control Example

In this example, the PSP function is used in conjunction with the PMM function. The PMM function determines when the missing tooth occurs, and the PSP function waits a programmable amount of time before it generates an output pulse. The PSP function has two operating modes, angle-angle and angle-time, and it generates the output pulse based on five parameters: RATIO1, RATIO2, ANGLE1, ANGLE2, and HIGH_TIME. RATIO1 and RATIO2 are 8-bit numbers that represent a decimal multiplier of the period that can range from 0 to 1.99. ANGLE1 and ANGLE2 represent reference angles. A reference angle is simply a tooth number. The teeth are numbered starting with 0 after the missing transition. HIGH_TIME specifies the time duration of the output pulse in angle-time mode. In this example, the PSP function uses the angle-time mode.

The PMM function has two modes: count mode and bank mode. In count mode, timer TCR2 is reset after the number of missing transitions in MAX_MISSING has been counted. In bank mode, timer TCR2 is reset after a missing transition only if BANK_SIGNAL is a non-zero value. In this example, the PMM function uses the count mode.

8.1.2 Hardware Setup

The input pulse train to the PMM channel and to the T2CLK input mimics the flywheel in an automobile engine. In this example, the flywheel has 35 teeth and one missing tooth (36 evenly spaced tooth positions total). See **Figure 11** below for an illustration of this input pulse.

FLYWHEEL INPUT TO PMM AND T2CLK

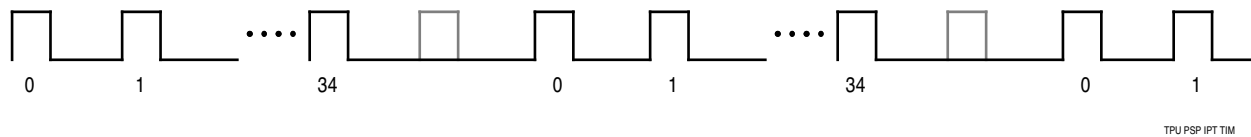
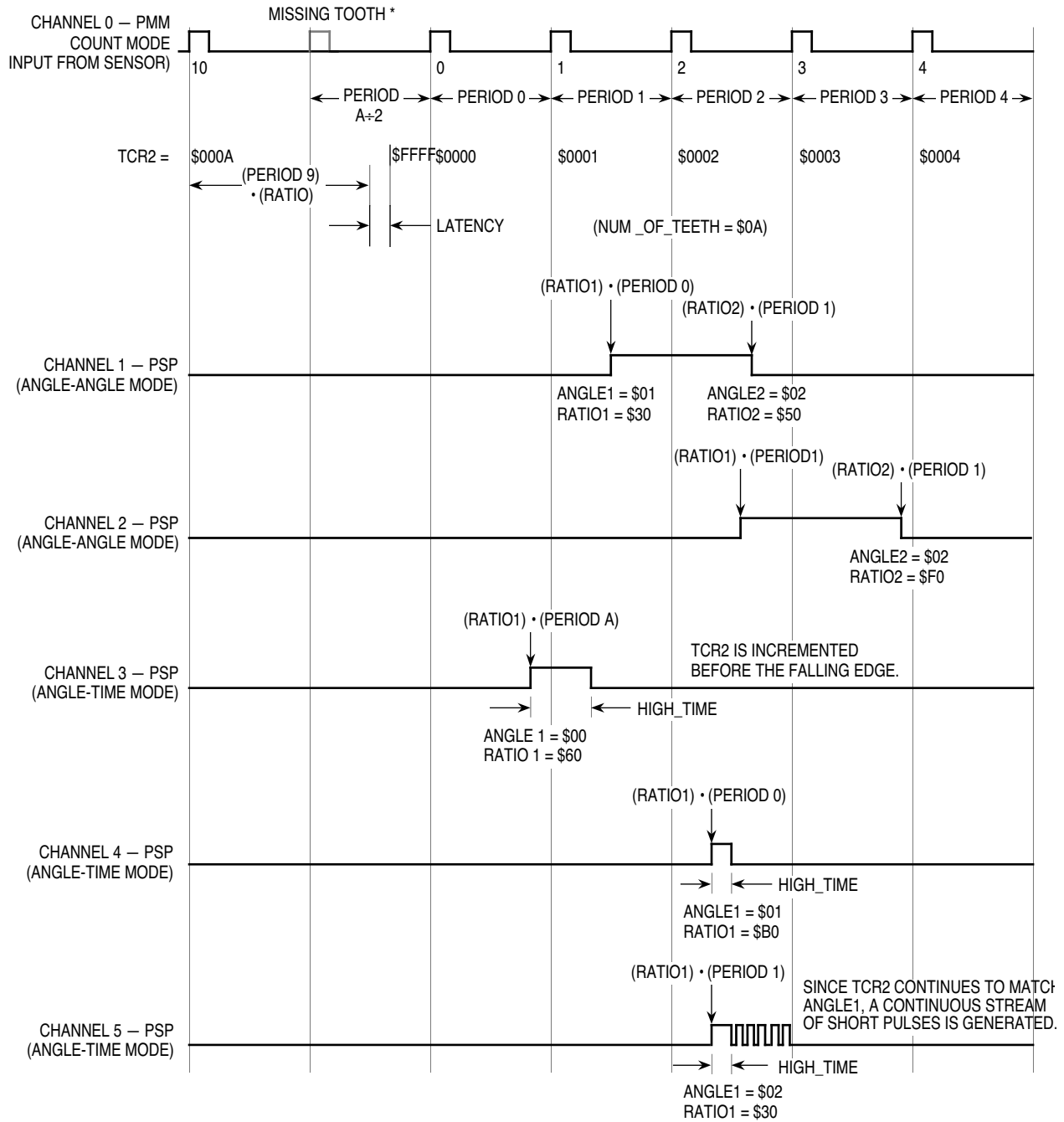

Figure 11 Input Pulse Train

In this example, the PMM function is on channel 4, and the PSP function is on channel 5. The PSP function is not physically connected to any of the other channels, but its parameter PERIOD_ADDRESS points to the PMM parameter PERIOD_LOW_WORD.

8.1.3 Output Waveform

Channel 3 in **Figure 12** shows the output waveform produced by this example.



* MISSING TOOTH – ONE TOOTH EVERY 30°, LESS ONE TOOTH RESULTS IN A TOTAL OF 11 TEETH.

1037A

Figure 12 Output Waveform for Example A

8.2 Program Code for CPU32-Based Microcontrollers

This program is a demonstration of how to use the PMM and PSP functions together to generate an output pulse in relation to a “missing tooth.” In this case, the input pulse train to the PMM channel and T2CLK is a series of 35 pulses followed by a 36th missing transition.

This program was assembled using the IASM32 assembler available from P&E Microcomputer Systems with the M68332 In-Circuit Debugger. It was run on an M68332EVS and BCC.

8.2.1 Initialization

Channel 4 is configured as a PMM channel, and channel 5 is configured as a PSP function. PMM is in count mode, and PSP is in angle-time mode.

```

TPUMCR      equ    $fffe00
TICR        equ    $fffe08
CIER        equ    $fffe0a
CFSR0       equ    $fffe0c
CFSR1       equ    $fffe0e
CFSR2       equ    $fffe10
CFSR3       equ    $fffe12
HSQR0       equ    $fffe14
HSQR1       equ    $fffe16
HSRR0       equ    $fffe18
HSRR1       equ    $fffe1a
CPR0        equ    $fffe1c
CPR1        equ    $fffe1e
PRAM4_0     equ    $ffff40
PRAM4_1     equ    $ffff42
PRAM4_2     equ    $ffff44
PRAM4_3     equ    $ffff46
PRAM4_4     equ    $ffff48
PRAM4_5     equ    $ffff4a
PRAM5_0     equ    $ffff50
PRAM5_1     equ    $ffff52
PRAM5_2     equ    $ffff54
PRAM5_3     equ    $ffff56
PRAM5_4     equ    $ffff58
PRAM5_5     equ    $ffff5a

org          $4000                ;begin program at memory location $4000
move.w      #$00cb,(CFSR2).l      ;Channel function select field (Note: function numbers
                                   ;may vary for different mask sets)
move.w      #$0700,(HSQR1).l     ;HSQR1, PSP in angle-time mode
                                   ;PMM in count mode
move.w      #$0f00,(CPR1).l      ;CPR1, high priority to both channels

```

8.2.2 PMM Initialization for Channel 4

```

move.w      #$0004,(PRAM4_0).l ;Channel control reg., detect rising edge
move.w      #$0122,(PRAM4_1).l ;MAX_MISSING = 1, NUM_OF_TEETH = 34
move.w      #$a022,(PRAM4_3).l ;RATIO=$a0, TCR2_MAX_VALUE=34

```

8.2.3 PSP Initialization for Channel 5

```

move.w      #$4a01,(PRAM5_0).l ;PERIOD_ADDRESS points to
                                   ;PERIOD_LOW_WORD of PMM
                                   ;Force pin high in force mode
move.w      #$6000,(PRAM5_4).l ;RATIO1 = $60, ANGLE1 = $00
move.w      #$0200,(PRAM5_5).l ;HIGH_TIME = $200

start
move.w      #$0900,(HSRR1).l    ;host service initialization request for channels 4 and 5
finish
bra        finish

```

8.3 Program Code for CPU16-Based Microcontrollers

This program was assembled using the IASM16 assembler from P&E Microcomputer Systems with the ICD16 In-Circuit Debugger. It was run on an MC68HC16Y1 EVB.

8.3.1 Initialization

Channel 4 is configured as a PMM channel, and channel 5 is configured as a PSP function. PMM is in count mode, and PSP is in angle-time mode.

```

TPUMCR      equ    $fe00
TICR        equ    $fe08
CIER        equ    $fe0a
CFSR0       equ    $fe0c
CFSR1       equ    $fe0e
CFSR2       equ    $fe10
CFSR3       equ    $fe12
HSQR0       equ    $fe14
HSQR1       equ    $fe16
HSRR0       equ    $fe18
HSRR1       equ    $fe1a
CPR0        equ    $fe1c
CPR1        equ    $fe1e
PRAM4_0     equ    $ff40
PRAM4_1     equ    $ff42
PRAM4_2     equ    $ff44
PRAM4_3     equ    $ff46
PRAM4_4     equ    $ff48
PRAM4_5     equ    $ff4a
PRAM5_0     equ    $ff50
PRAM5_1     equ    $ff52
PRAM5_2     equ    $ff54
PRAM5_3     equ    $ff56
PRAM5_4     equ    $ff58
PRAM5_5     equ    $ff5a
    
```

The following code is included to set up the reset vector (\$00000 – \$00006). It may be changed for different systems.

```

ORG    $0000                ;put the following reset vector information
                                ;at address $00000 of the memory map
DW     $0000                ;zk=0, sk=0, pk=0
DW     $0200                ;pc=200 -- initial program counter
DW     $3000                ;sp=3000 -- initial stack pointer
DW     $0000                ;iz=0 -- direct page pointer
org    $0400                ;begin program at memory location $0400
    
```

The following code initializes and configures the system including the Software Watchdog and System Clock. It was written to be used with an EVB.

```

INITSYS:                    ;give initial values for extension registers
                                ;and initialize system clock and COP
LDAB   #$0F
TBK    LDAB   #$00                ;point EK to bank F for register access
TBK    TBK    ;point XK to bank 0
TBK    TBK    ;point YK to bank 0
TBK    TBK    ;point ZK to bank 0
LDD    #$0003                ;at reset, the CSBOOT block size is 512K.
STD    CSBARBT                ;this line sets the block size to 64K since
                                ;that is what physically comes with the EVB16
LDAA   #$7F                  ;w=0, x=1, y=111111
STAA   SYNCR                  ;set system clock to 16.78 MHz
CLR    SYPCR                  ;turn COP (software watchdog) off,
                                ;since COP is on after reset
    
```



```

lds      #$f000
**** MAIN PROGRAM ****
ldab    #$0f
tбек    ;use bank $0f for parameter RAM
ldd     #$00cb
std     CFSR2      ;Channel function select field (Note: function numbers
ldd     #$0700    ;may vary for different mask sets)
std     HSQR1     ;HSQR1, PSP in angle-time mode, PMM in count mode
ldd     #$0f00
std     CPR1      ;CPR1, high priority to both channels

```

8.3.2 PMM Initialization for Channel 4

```

ldd     #$0004
std     PRAM4_0   ;Channel control reg., detect rising edge
ldd     #$0122
std     PRAM4_1   ;MAX_MISSING = 1, NUM_OF_TEETH = 34
ldd     #$a022
std     PRAM4_3   ;RATIO=$a0, TCR2_MAX_VALUE=34

```

8.3.3 PSP Initialization for Channel 5

```

ldd     #$4a01
std     PRAM5_0   ;PERIOD_ADDRESS points to
                    ;PERIOD_LOW_WORD of PMM
                    ;Force pin high in force mode

ldd     #$6000
std     PRAM5_4   ;RATIO1 = $60, ANGLE1 = $00
ldd     #$0200
std     PRAM5_5   ;HIGH_TIME = $200

start
ldd     #$0900
std     HSRR1     ;host service initialization request for channels 4 and 5

finish
bra     finish

```

9 Function Algorithm

If periods longer than \$8000 are to be measured before generating a transition ($HIGH_TIME > \$8000$, or $period * RATIO1 > \$8000$), the following method is used:

1. A match on (current time + \$8000) is set, the PAC is set for no change on match, and the remaining period to be measured is stored in `RATIO_TEMP`.
2. When the match event occurs, a match on the value stored in `RATIO_TEMP` is then set and PAC configured such that the pin changes when the new match event occurs.

When the next angle to be matched is less than the last angle matched, the following steps are used:

1. A match on last angle plus \$8000 is set; and
2. A match on the next angle is set.

The following paragraphs summarize the PSP time function. This description is provided as a guide only, to aid understanding of the function. The exact sequence of operations in microcode may be different from that shown, in order to optimize speed and code size. TPU microcode source listings for all functions in the TPU function library can be downloaded from the Freescale Freeware bulletin board. Refer to *Using the TPU Function Library and TPU Emulation Mode* (TPUPN00/D) for detailed instructions on downloading and compiling microcode.

```

PROCEDURE Next state(state){
  Switch(state){
    State Trans_H_L
      Set TBS to match TCR1, capture TCR1
      Set PAC to high to low

```

```

    Assert channel flag0
    Negate channel flag1
State ANGLE1_gt_8000
    Set TBS to match TCR2, capture TCR1
    Set PAC to no change
    Assert channel flag1
State TCR2_eq_ANG1
    Set TBS to match TCR2, capture TCR1
    Set PAC to no change
    Negate channel flag0
    Negate channel flag1
State RATIO1_gt_8000
    Set TBS to match TCR1, capture TCR1
    Set PAC to no change
    Negate channel flag0
    Assert channel flag1
State Trans_L_H
    Set TBS to match TCR1, capture TCR1
    Set PAC to low to high
    Assert channel flag0
    Negate channel flag1
State ANG1_gt_ANG2
    Set TBS to match TCR2, capture TCR1
    Set PAC to no change
    Assert channel flag0
    Assert channel flag1
State TCR2_eq_ANG2
    Set TBS to match TCR2, capture TCR1
    Set PAC to no change
    Negate channel flag0
    Negate channel flag1
State RATIO2_gt_8000
    Set TBS to match TCR1, capture TCR1
    Set PAC to no change
    Negate channel flag0
    Assert channel flag1
}
}

```

The individual states of the PSP time function are described in detail in the following paragraphs.

9.1 State 1: *Init*

Condition: HSR1, HSR0, M/TSR, LSR, Pin, Flag0 = 10xxxx.

Match Enable: Disable

Summary:

This state is entered as the result of an HSR%10 for initialization. In this state, the channel latches are configured, and the following occurs for mode 0:

- If $ANGLE1 - TCR2 > \$8000$, generate match on $ANGLE2 + \$8000$ (next state: *Angle1_gt_8000*);
- Else generate match on ANGLE1 (next state: *TCR2_eq_Angle1*)

In mode 1, channel latches are configured, and the following occurs:

- If $ANGLE1 - TCR2 > \$8000$, generate match on $ANGLE1 + \$8000$ (next state: *Angle1_gt_8000*);
- Else generate match on $ANGLE1$ (next state: *TCR2_eq_Angle1*)

Algorithm:

```

Set pin low
/* The TPU accesses ANGLE1 and RATIO1 coherently */
/* The TPU prepares first transition */

If  $ANGLE1 - TCR2 \leq \$8000$  then {
    RATIO_TEMP = RATIO1, ANGLE1
    R2_A2_TEMP = RATIO2, ANGLE2
    Generate match at time = ANGLE1
/* or HIGH_TIME */
/* next state (TCR2_eq_ANGLE1) */
}
Else {
    If host sequence bit 0 = 1
    Then {
        Generate match at time =  $\$8000 + ANGLE1$ 
/* Mode 1 HIGH_TIME mode */
/* next state(ANGLE1_gt_8000) */
    }
    Else {
        Generate match at time =  $\$8000 + ANGLE2$ 
/* Mode 0 ANGLE_ANGLE mode */
/* next state(ANGLE1_gt_8000)*/
    }
}
    
```

9.2 State 2: *Trans_H_L*

9.3 State 3: *Angle1_gt_8000*

Condition: HSR1, HSR0, M/TSR, LSR, Pin, Flag0 = 001001.

Match Enable: Enable

State 2 Summary:

This state is entered when a high-to-low pin transition results from a match event involving TCR1. In this state the following occurs for mode 0:

- If $ANGLE1 \leq ANGLE2$ generate match on $ANGLE2 + \$8000$ (next state: *Angle1_gt_8000*)
- Else generate match on $ANGLE1$ (next state: *TCR2_eq_Angle1*)

In mode 1, the following occurs:

- If $ANGLE1 - TCR2 > \$8000$, generate match on $ANGLE1 + \$8000$ (next state: *Angle1_gt_8000*);
- Else generate match on $ANGLE1$ (next state: *TCR2_eq_Angle1*)

State 3 Summary:

This state is entered when no pin transition results due to a match event with TCR2. In angle-angle mode, this state is entered when $ANGLE2$ is greater than $ANGLE1$. In this state a match event on $ANGLE1$ is set up.

Algorithm (States 2 and 3):

```

If channel flag1 = 0 then {
/* Trans_H_L (state 2) */
    Assert interrupt request
    OLD_ANGLE2 = RATIO_TEMP
/* ANGLE2 */
    If host sequence bit 0 = 1 then {
/* Mode 1 */
    }
}
    
```

```

If ANGLE1 – TCR2 ≤ $8000 then {
    RATIO_TEMP = RATIO1, ANGLE1
    R2_A2_TEMP = RATIO2, ANGLE2
    Generate match at time = ANGLE1
                                                    /* next state (TCR2_eq_ANGLE1) */
}
Else {
    Generate match at time = $8000 + ANGLE1
                                                    /* next state (ANGLE1_gt_8000) */
}
}
Else {
                                                    /* Mode 0 */
If ANGLE1 ≤ OLD_ANGLE2 then {
    Generate match at time = $8000 + OLD_ANGLE2
                                                    /* next state (ANGLE1_gt_8000) */
}
Else {
                                                    /* ANGLE1 > OLD_ANGLE2 and MODE 0 */
    RATIO_TEMP = RATIO1, ANGLE1
    R2_A2_TEMP = RATIO2, ANGLE2
                                                    /* TCR2 has passed ANGLE1 and ANGLE1 > ANGLE2
If TCR2 = FFFF, 0, 1 then TCR2 < OLD_ANGLE2
If TCR2 = FFFF a match on ANGLE1 will be
delayed a whole turn of TCR2, therefore
generate an immediate match */
If ((TCR2 – OLD_ANGLE2) < 0) and
((TCR2 + 1 – OLD_ANGLE2) < $8000)Then {
    Generate match at time = TCR2
}
                                                    /* next state(TCR2_eq_ANGLE1) */
Else {
    Generate match at time = RATIO_TEMP
                                                    /* ANGLE1 */
}
                                                    /* next state(TCR2_eq_ANGLE1) */
}
Else {
                                                    /* channel flag1 = 1: ANGLE1_gt_8000 (state 3) */
    RATIO_TEMP = RATIO1, ANGLE1
    R2_A2_TEMP = RATIO2, ANGLE2
                                                    /* or HIGH_TIME */
    Generate match at time = ANGLE1
                                                    /* next state (TCR2_eq_ANGLE1) */
}
}

```

9.4 State 4: *TCR2_eq_Angle1*

9.5 State 5: *Ratio1_gt_8000*

Condition: HSR1, HSR0, M/TSR, LSR, Pin, Flag0 = 001000.

Match Enable: Enable

State 4 Summary:

This state is entered when no pin transition results due to a match event with TCR2. During this state the TPU calculates the offset from the occurrence of ANGLE1, or the TCR1 time of ANGLE1, to the rising transition of the pulse. This calculation is accomplished with the multiplication of the reference period (at PERIOD_ADDRESS) by RATIO1. If the offset is \leq \$8000, a match event is set up with the offset from the TCR1 time of ANGLE1 (next state: *Trans_L_H*). Else a match event is set up with the offset + \$8000 from the TCR1 time of ANGLE1 (next state: *Ratio1_gt_8000*).

State 5 Summary:

This state is entered when no pin transition results due to a match event with TCR1. In this state, a match event on the previous match value + \$8000 is set up. When the match event occurs, a low-to-high pin transition results.

Algorithm (States 4 and 5):

```

If (channel flag1 = 0) then {
    /* TCR2_eq_ANGLE1 (state 4) */
    If host sequence bit 0 = 0 then ANGLE_TIME = ERT
    RESULT = RATIO_TEMP * (PERIOD_ADDRESS) / 128
    /* RATIO1 byte of RATIO_TEMP used for multiplication */
    If (RESULT ≤ $8000) Then {
        Generate match at time = ERT + RESULT
    }
    /* next state (Trans_L_H) */
    Else {
        /* (RESULT > $8000) */
        Generate match at time = ERT + RESULT – $8000
    }
    /* next state (RATIO1_gt_$8000) */
}
Else {
    /* channel flag1 = 1, RATIO1_gt_$8000 (state 5) */
    Generate match at time = MATCH_REGISTER + $8000
    /* next state (Trans_L_H) */
}
    
```

9.6 State 6: *Trans_L_H*

9.7 State 7: *Angle1_gt_Angle2*

Condition: HSR1, HSR0, M/TSR, LSR, Pin, Flag0 = 001011.

Match Enable: Enable

State 6 Summary:

This state is entered when a low-to-high pin transition results after a match event involving TCR1. In this state the following occurs for mode 0:

- If ANGLE1 = ANGLE2, calculate offset as described in *TCR2_eq_Angle2* and generate match (next state: see state *TCR2_eq_Angle2*)
- If ANGLE1 > ANGLE2, generate match on ANGLE1 + \$8000 (next state: *Angle1_gt_Angle2*)
- Else generate match on ANGLE2 (next state: *TCR2_eq_Angle2*).

In mode 1, the following occurs:

- If HIGH_TIME > \$8000, generate match on low-to-high transition time + HIGH_TIME + \$8000 (next state: *Ratio2_gt_\$8000*)
- Else generate match on low-to-high transition time + HIGH_TIME (next state: *Trans_H_L*).

State 7 Summary:

This state is entered, in angle-angle mode, when no pin transition results after a match with TCR2. In this state a match event on ANGLE2 is set up.

Algorithm (States 6 and 7):

```

If (host sequence bit 0 = 1) then {
    /* state = Trans_L_H (state 6) for Mode 1 */
    ERT = MATCH_REGISTER
    ANGLE_TIME = ERT
    /* Store transition time */
}
    
```

```

Assert interrupt request
RESULT = R2_A2_TEMP                                /* HIGH_TIME */
If (RESULT ≤ $8000) then {
    Generate match at time = ERT + RESULT
                                                    /* next state (Trans_H_L) */
}
Else {
    Generate match at time = ERT + RESULT - $8000
                                                    /* RESULT > $8000 */
                                                    /* next state (RATIO2_gt_$8000) */
}
}
Else {
                                                    /* (host sequence bit 0 = 0) Mode 0 */
    If (channel flag1 = 0) then {
                                                    /* Trans_L_H state for Mode 0 */
        Assert interrupt request
            /* RATIO_TEMP = RATIO1, ANGLE1 and R2_A2_TEMP = RATIO2, ANGLE2 */
        If (RATIO_TEMP = R2_A2_TEMP) Then {
            /* ANGLE1 = ANGLE2 */
            RATIO_TEMP = R2_A2_TEMP
            ERT = ANGLE_TIME
            RESULT = RATIO_TEMP * @
                (PERIOD_ADDRESS) / 128
                /* RATIO2 byte of RATIO_TEMP used for multiplication */
            TCR1_TEMP = TCR1
            ELAPSED_TIME = TCR1_TEMP - ANGLE_TIME
            MATCH_ABS = ANGLE_TIME + RESULT
            Goto COMPUTE_FALLING_EDGE
        }
        Else {
                                                    /* ANGLE1 - ANGLE2 */
            If (RATIO_TEMP > R2_A2_TEMP)
                Then {
                                                    /* ANGLE1 > ANGLE2 */
                    Generate match at time = $8000 +
                        RATIO_TEMP
                                                    /* $8000 + ANGLE1 */
                                                    /* next state(ANGL1_gt_ANGL2) */
                }
            Else {
                                                    /* ANGLE1 < ANGLE2 */
                If ((TCR2 - RATIO_TEMP < 0) and
                    ((TCR2 + 1 - RATIO_TEMP < $8000) Then {
                                                    /* see the dual case description
                                                    in the TRANS_H_L state */
                    RATIO_TEMP = R2_A2_TEMP
                    Generate match at time = TCR2
                }
            }
            Else {
                RATIO_TEMP = R2_A2_TEMP
                Generate match at time = RATIO_TEMP
            }
        }
                                                    /* next state (TCR2_eq_ANGL2) */
    }
}
Else {
                                                    /* Channel flag1 = 1, state = ANGL1_gt_ANGL2 (state 7) */
    RATIO_TEMP = R2_A2_TEMP
    Generate match at time = RATIO_TEMP
                                                    /* next state (TCR2_eq_ANGL2) */
}
}
}
}

```

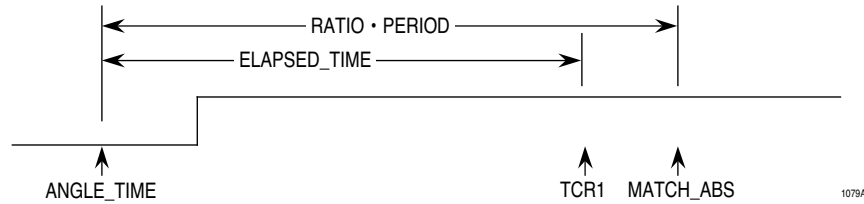

Figure 13 ANGLE1 = ANGLE2 Low to High Transition

Figure 13 illustrates the following process:

If $ELAPSED_TIME \geq RATIO2 * PERIOD$ then generate immediate match

Else

If $MATCH_ABS - TCR1 > \$8000$ then generate match on $MATCH_ABS - \$8000$

Else generate match on $MATCH_ABS$

9.8 State 8: *TCR2_eq_Angle2*

9.9 State 9: *Ratio2_gt_8000*

Condition: HSR1, HSR0, M/TSR, LSR, Pin, Flag0 = 001010

Match Enable: Enable

State 8 Summary:

This state is entered, in angle-angle mode, when no pin transition results after a match event with TCR2. During this state the TPU calculates the offset from the occurrence of ANGLE2, or the TCR1 time of ANGLE2, to the falling transition of the pulse. This calculation is accomplished by multiplying the reference period (at PERIOD_ADDRESS) by RATIO2. If the offset $\leq \$8000$, a match event is set up with the offset from the TCR1 time of ANGLE2 (next state: *Trans_H_L*). Else a match event is set up with the offset + \$8000 from the TCR1 time of ANGLE2 (next state: *Ratio2_gt_8000*).

State 9 Summary:

This state is entered when no pin transition results due to a match event with TCR1. In this state, a match event on the previous match value + \$8000 is set up. When the match event occurs, a high-to-low pin transition results.

Algorithm (States 8 and 9):

```

If (channel flag1 = 0) then {
    RESULT = RATIO_TEMP(RATIO2) * @(PERIOD_ADDRESS) / 128
    TCR1_TEMP = TCR1
    ELAPSED_TIME = TCR1_TEMP - ANGLE_TIME
    MATCH_ABS = ANGLE_TIME + RESULT
    Goto COMPUTE_FALLING_EDGE
}
Else {
    Generate match at time = MATCH_REGISTER + $8000
}
    
```

9.10 State 10: *Immed_L*

Condition: HSR1, HSR0, M/TSR, LSR, Pin, Flag0 = 01xx0x.

Match Enable: Disable

Summary:

This state is entered as the result of an HSR for an immediate update (01) when the pin is low. This state causes an immediate update (recomputation) of the pulse if specific conditions (see **5 Host Interface to Function**) are met.

Algorithm:

```

If (host sequence bit 1 = 1) Then {
    R2_A2_TEMP = RATIO2, ANGLE2
}
Else {
    If (TCR2 < ANGLE1) Then {
        Generate match at time = ANGLE1
        RATIO_TEMP = ratio1, ANGLE1
        R2_A2_TEMP = RATIO2, ANGLE2
        Generate match at time = ANGLE1
    }
    Else {
    }
}

```

/* change the falling time */
/* or HIGH_TIME */

/* change rising and falling times coherently */
/* generate a match on ANGLE1 */

/* access parameters coherently */

/* or HIGH_TIME */

/* next state (TCR2_eq_ANGLE1) */

/* It's too late - do nothing */

9.11 State 11: *Immed_H*

Condition: HSR1, HSR0, M/TSR, LSR, Pin, Flag0 = 01xx1x.

Match Enable: Disable

Summary:

This state is entered as the result of an HSR for an immediate update (01) when the pin is high. This state causes an immediate update (recomputation) of the falling edge of the pulse if specific conditions (see **5 Host Interface to Function**) are met.

Algorithm:

```

If (host sequence bit 1 = 0) Then {
    Do nothing
}
Else If (host sequence bit 0 = 0) Then {
    NEW_A1 = ANGLE1
    NEW_A2 = ANGLE2
    R2_A2_TEMP = NEW_R2, NEW_A2
    RATIO_TEMP = NEW_R2, NEW_A2
    If (NEW_A2 - TCR2 < $8000) Then {
        Generate match at time = RATIO_TEMP
    }
    Else If (NEW_A1 > NEW_A2) Then {
        Generate match on OLD_A1 + $8000
    }
    Else If (NEW_A1 < NEW_A2) Then {

```

/* immediate high service request is to be ignored */

/* MODE 0 */
/* access parameters coherently */

/* update RATIO_TEMP */

/* generate a match on ANGLE2 */
/* next state(TCR2_eq_ANGLE2) */

/* TCR2 > NEW_ANGLE2 */

/* next state (ANGL1_gt_ANGLE2) */

```

Generate match on TCR2
                                                                    /* immediate match */
                                                                    /* next state (TCR2_eq_ANGL2) */
}
Else If (NEW_A1 = NEW_A2) Then {
                                                                    /* treat like A1 = A2 */
    RESULT = RATIO2 * (PERIOD_ADDRESS)/128
    TCR1_TEMP = TCR1
    ELAPSED_TIME = TCR1_TEMP - ANGLE_TIME
    MATCH_ABS = ANGLE_TIME + RESULT
    Goto COMPUTE FALLING EDGE
}
}
Else {
    /* host sequence bit 0 = 1: HIGH_TIME MODE */
    R2_A2_TEMP = RATIO2, ANGLE2
                                                                    /* HIGH TIME */
    If (MRL = 1 and Channel flag0 = 1) Then {
                                                                    /* Match on low to high detected */
        Goto state Trans_L_H_Mode1
    }
    Else {
                                                                    /* sample TCR1 */
        TCR1_TEMP = TCR1
        ELAPSED_TIME = TCR1_TEMP - ANGLE_TIME
        MATCH_ABS = ANGLE_TIME + R2_A2_TEMP
    }
}
COMPUTE FALLING EDGE:
If (ELAPSED_TIME ≤ R2_A2_TEMP) Then {
    Generate immediate match on TCR1
                                                                    /* next state (Trans_H_L) */
}
Else If (TCR1_TEMP - MATCH_ABS < $8000)Then
{
    /* generate match on ANGLE_TIME + HIGH_TIME - 8000 */
    Generate match at time = MATCH_ABS - 8000
                                                                    /* next state (RATIO2_gt_8000) */
}
Else {
    /* generate match on ANGLE_TIME + HIGH_TIME */
    Generate match at time = MATCH_ABS
                                                                    /* next state (Trans_H_L) */
}
}
}

```

9.12 State 12: Force_Mode

Condition: HSR1, HSR0, M/TSR, LSR, Pin, Flag0 = 11xxxx.

Match Enable: Disable

Summary:

This state is entered as the result of an HSR %11 in response to an error condition from the input channel. The pin is set as indicated by CHANNEL_CONTROL. Further service requests due to match/transition events are ignored.

Algorithm:

Configure channel latches via CHANNEL_CONTROL
 Disable service request (PAC is set to no change by CHANNEL_CONTROL)

The table below shows the PSP state transitions listing the service request sources and channel conditions from current state to next state. **Figure 14** illustrates the flow of PSP states for angle-angle mode, and **Figure 15** illustrates the flow of PSP states for angle-time mode. Each figure includes initialization and force modes.

Table 3 PSP State Transition Table

Current State	HSR	M/T	LSR	Pin	Flag0	Flag1	Next State
Any State	11	—	—	—	—	—	S 12 Force_Mode
Any State	10	—	—	—	—	—	S1 Initialization
Any State	01	—	—	1	—	—	S11 Immed_H
Any State	01	—	—	0	—	—	S10 Immed_L
S1 Init	00 00 00	1 1 1	— — —	0 0 1	1 0 1	1 0 0	S3 Angle1_gt_\$8000 S4 TCR2_eq_Angle1 S6 Trans_L_H
S2 Trans_H_L	00 00 00	1 1 1	— — —	0 0 1	1 0 1	1 0 0	S3 Angle1_gt_\$8000 S4 TCR2_eq_Angle1 S6 Trans_L_H
S3 Angle1_gt_\$8000	00 00	1 1	— —	0 1	0 1	0 0	S4 TCR2_eq_Angle1 S6 Trans_L_H
S4 TCR2_eq_Angle1	00 00	1 1	— —	0 1	0 1	1 0	S5 Ratio1_gt_\$8000 S6 Trans_L_H
S5 Ratio1_gt_\$8000	00	1	—	1	1	0	S6 Trans_L_H
S6 Trans_L_H	00 00 00 00	1 1 1 1	— — — —	0 1 1 1	1 1 0 0	0 1 0 1	S2 Trans_H_L S7 Angle1_gt_Angle2 S8 TCR2_eq_Angle2 S9 Ratio2_gt_\$8000
S7 Angle1_gt_Angle2	00 00	1 1	— —	1 0	0 1	0 0	S8 TCR2_eq_Angle2 S2 Trans_H_L
S8 TCR2_eq_Angle2	00 00	1 1	— —	1 0	0 1	1 0	S9 Ratio2_gt_\$8000 S2 Trans_H_L
S9 Ratio2_gt_\$8000	00	1	—	0	1	0	S2 Trans_H_L
S10 Immed_L	00	1	—	0	0	0	S4 TCR2_eq_Angle1
S11 Immed_H	00 00 00 00	1 1 1 1	— — — —	0 1 1 1	1 1 0 0	0 1 0 1	S2 Trans_H_L S7 Angle1_gt_Angle2 S8 TCR2_eq_Angle2 S9 Ratio2_gt_\$8000
Unimplemented Conditions	00 00	0 —	— 1	— —	— —	— —	— —

NOTES:

1. Conditions not specified are “don't care.”
2. HSR = Host service request
LSR = Link service request
M/TSR = Either a match or transition (input capture) service request occurred (M/TSR = 1) or neither occurred (M/TSR = 0).

KEY:

HSR	M/TSR	LSR	PIN	FLAG0	FLAG1
XX	X	X	X	X	X

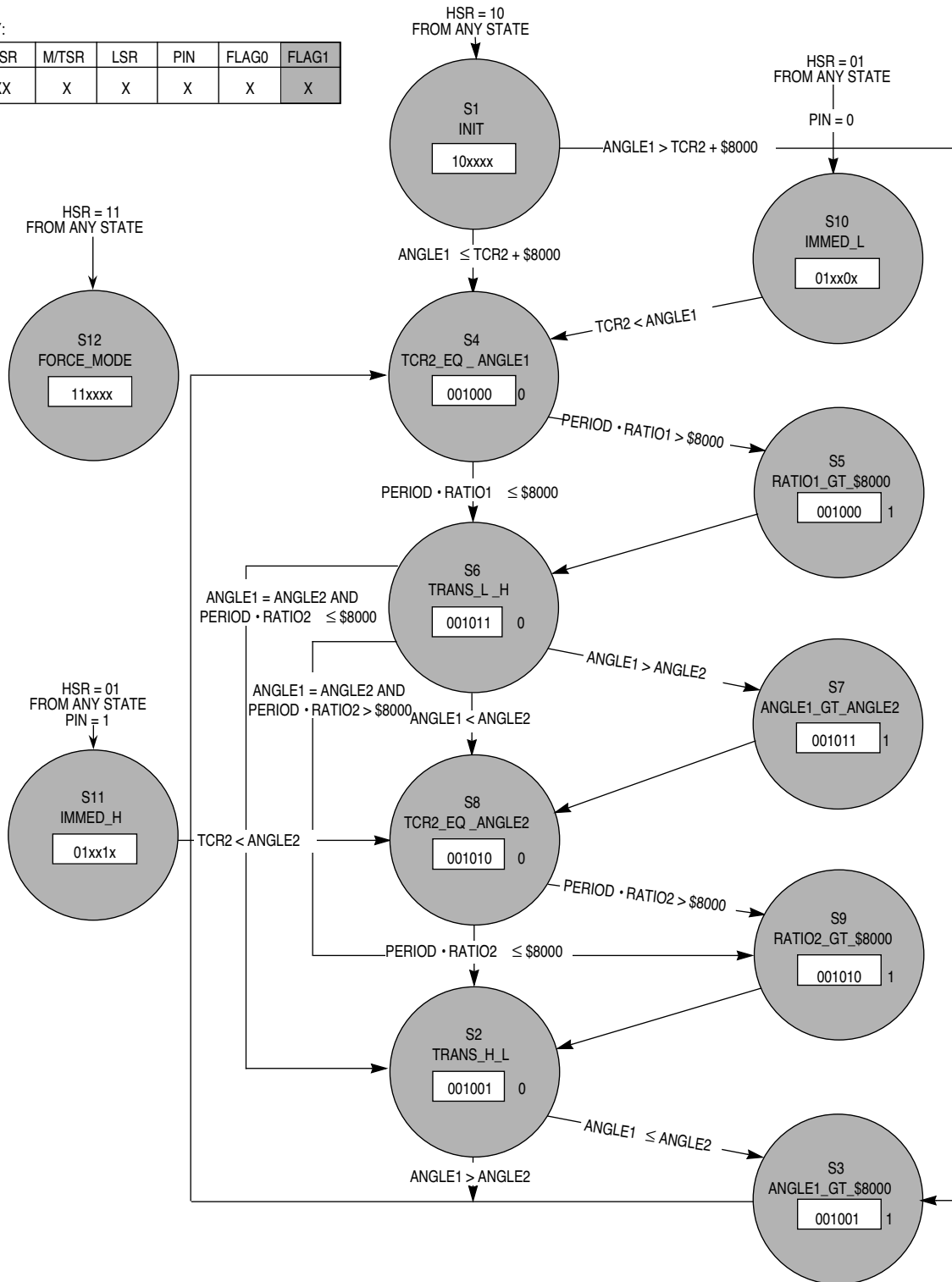

Figure 14 PSP Angle-Angle Mode State Flowchart

KEY:

HSR	M/TSR	LSR	PIN	FLAG0	FLAG1
XX	X	X	X	X	X

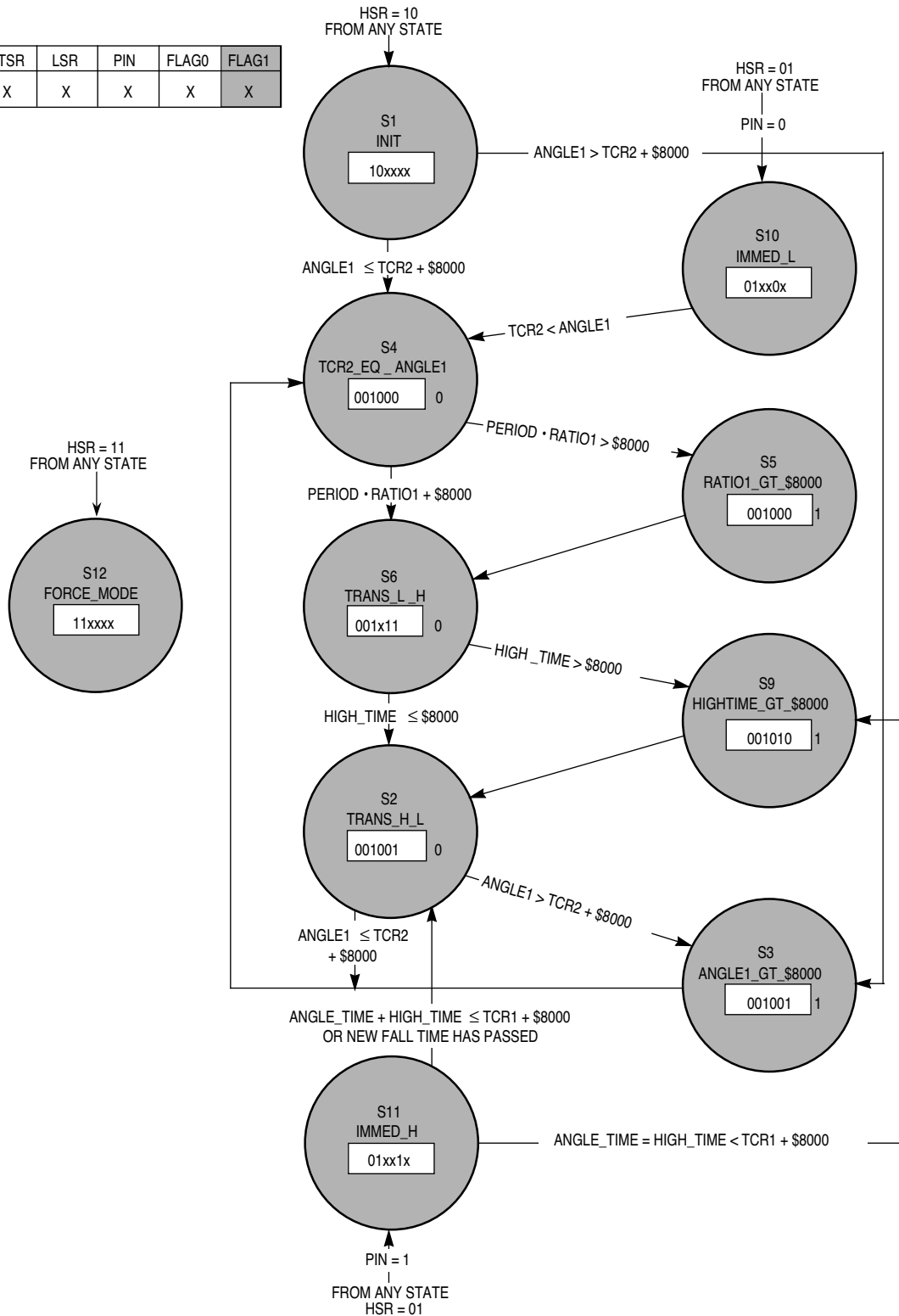

Figure 15 PSP Angle-Time Mode State Flowchart

Freescale Semiconductor, Inc.

How to Reach Us:

Home Page:

www.freescale.com

E-mail:

support@freescale.com

USA/Europe or Locations Not Listed:

Freescale Semiconductor
Technical Information Center, CH370
1300 N. Alma School Road
Chandler, Arizona 85224
+1-800-521-6274 or +1-480-768-2130
support@freescale.com

Europe, Middle East, and Africa:

Freescale Halbleiter Deutschland GmbH
Technical Information Center
Schatzbogen 7
81829 Muenchen, Germany
+44 1296 380 456 (English)
+46 8 52200080 (English)
+49 89 92103 559 (German)
+33 1 69 35 48 48 (French)
support@freescale.com

Japan:

Freescale Semiconductor Japan Ltd.
Headquarters
ARCO Tower 15F
1-8-1, Shimo-Meguro, Meguro-ku,
Tokyo 153-0064
Japan
0120 191014 or +81 3 5437 9125
support.japan@freescale.com

Asia/Pacific:

Freescale Semiconductor Hong Kong Ltd.
Technical Information Center
2 Dai King Street
Tai Po Industrial Estate
Tai Po, N.T., Hong Kong
+800 2666 8080
support.asia@freescale.com

For Literature Requests Only:

Freescale Semiconductor Literature Distribution Center
P.O. Box 5405
Denver, Colorado 80217
1-800-441-2447 or 303-675-2140
Fax: 303-675-2150
LDCForFreescaleSemiconductor@hibbertgroup.com

Information in this document is provided solely to enable system and software implementers to use Freescale Semiconductor products. There are no express or implied copyright licenses granted hereunder to design or fabricate any integrated circuits or integrated circuits based on the information in this document.

Freescale Semiconductor reserves the right to make changes without further notice to any products herein. Freescale Semiconductor makes no warranty, representation or guarantee regarding the suitability of its products for any particular purpose, nor does Freescale Semiconductor assume any liability arising out of the application or use of any product or circuit, and specifically disclaims any and all liability, including without limitation consequential or incidental damages. "Typical" parameters which may be provided in Freescale Semiconductor data sheets and/or specifications can and do vary in different applications and actual performance may vary over time. All operating parameters, including "Typicals" must be validated for each customer application by customer's technical experts. Freescale Semiconductor does not convey any license under its patent rights nor the rights of others. Freescale Semiconductor products are not designed, intended, or authorized for use as components in systems intended for surgical implant into the body, or other applications intended to support or sustain life, or for any other application in which the failure of the Freescale Semiconductor product could create a situation where personal injury or death may occur. Should Buyer purchase or use Freescale Semiconductor products for any such unintended or unauthorized application, Buyer shall indemnify and hold Freescale Semiconductor and its officers, employees, subsidiaries, affiliates, and distributors harmless against all claims, costs, damages, and expenses, and reasonable attorney fees arising out of, directly or indirectly, any claim of personal injury or death associated with such unintended or unauthorized use, even if such claim alleges that Freescale Semiconductor was negligent regarding the design or manufacture of the part.



**For More Information On This Product,
Go to: www.freescale.com**